

# PAVILLON ZEN 12' X 12'

12' x 12' Zen Pavilion

Référence / Reference : 27045

---

## GUIDE D'ASSEMBLAGE



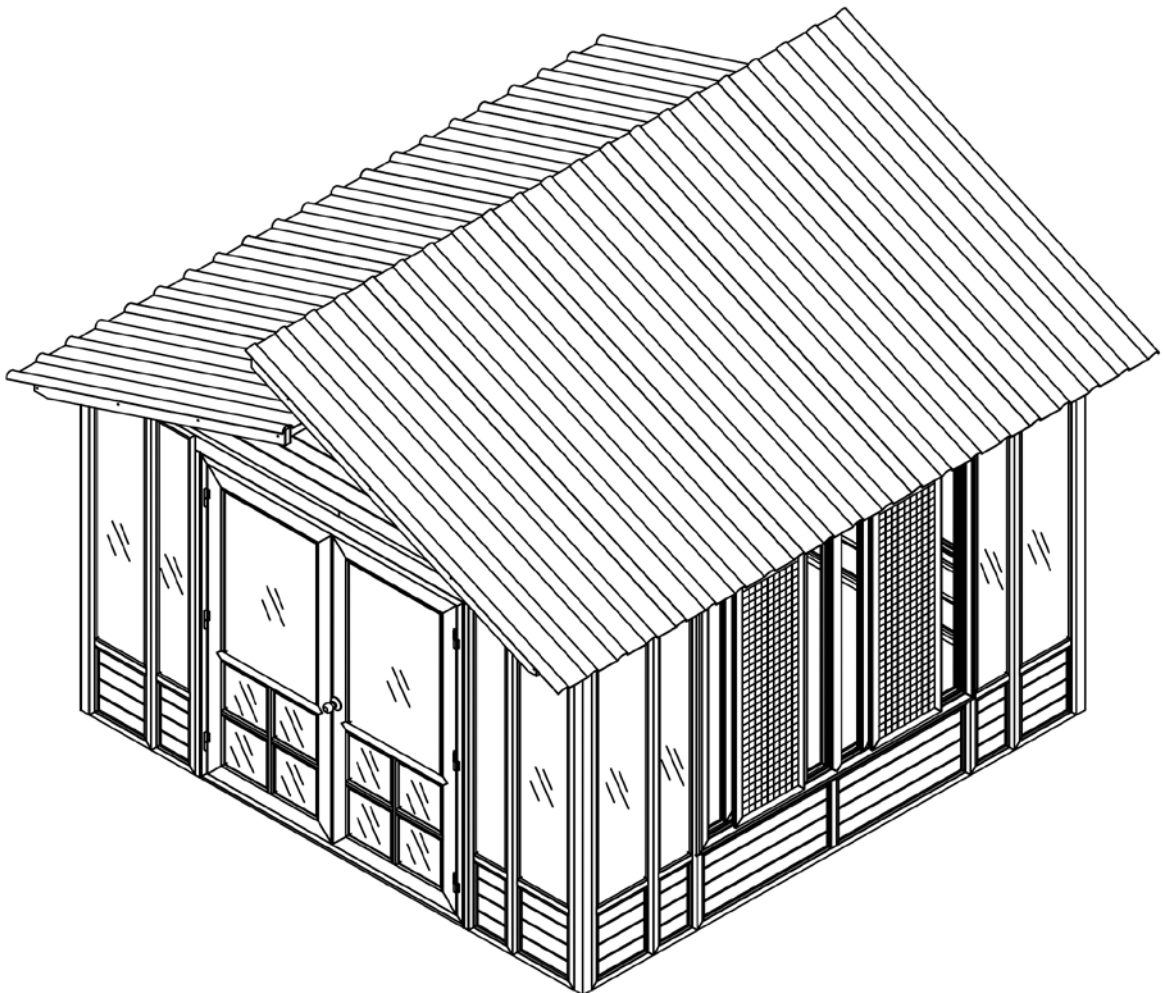







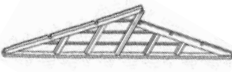

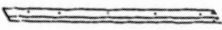

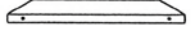

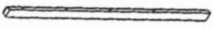

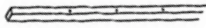
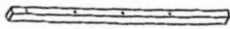
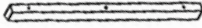
Assembly Instructions

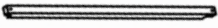

POUR TOUTE ASSISTANCE,  
CONTACTEZ VOTRE DÉTAILLANT.  
For assistance, contact your retailer.



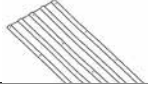
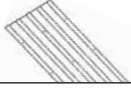











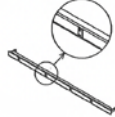

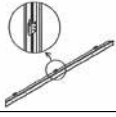





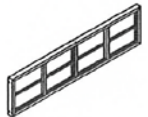



# PRÉASSEMBLAGE / PRE-ASSEMBLY

## Liste des pièces (1) / Parts List (1)

Pièce/ Part	Description	Qté / Qty	Pièce/ Part	Description	Qté / Qty	Pièce/ Part	Description	Qté / Qty
A1	 134 <sup>5</sup> / <sub>8</sub> " X 33 <sup>9</sup> / <sub>16</sub> " X 2 <sup>3</sup> / <sub>4</sub> "	x 1	A2	 134 <sup>5</sup> / <sub>8</sub> " X 33 <sup>9</sup> / <sub>16</sub> " X 2 <sup>3</sup> / <sub>4</sub> "	x 1	B	 137 <sup>5</sup> / <sub>8</sub> " X 33 <sup>3</sup> / <sub>4</sub> " X 5 <sup>1</sup> / <sub>2</sub> "	x 2
C1	 70 <sup>11</sup> / <sub>16</sub> " X 2 <sup>3</sup> / <sub>8</sub> " X 1 <sup>3</sup> / <sub>8</sub> "	x 4	C2	 70 <sup>11</sup> / <sub>16</sub> " X 2 <sup>3</sup> / <sub>8</sub> " X 1 <sup>3</sup> / <sub>8</sub> "	x 4	D	 23 <sup>1</sup> / <sub>4</sub> " X 3 <sup>1</sup> / <sub>2</sub> " X 1 <sup>3</sup> / <sub>8</sub> "	x 4
D1	 7" X 3 <sup>1</sup> / <sub>2</sub> " X 1 <sup>3</sup> / <sub>8</sub> "	x 4	E1	 56 <sup>3</sup> / <sub>16</sub> " X 2 <sup>3</sup> / <sub>8</sub> " X 1 <sup>3</sup> / <sub>8</sub> "	x 1	E2	 56 <sup>3</sup> / <sub>16</sub> " X 2 <sup>3</sup> / <sub>8</sub> " X 1 <sup>3</sup> / <sub>8</sub> "	x 1
E3	 42 <sup>1</sup> / <sub>8</sub> " X 2 <sup>3</sup> / <sub>8</sub> " X 1 <sup>3</sup> / <sub>8</sub> "	x 1	F1	 56 <sup>3</sup> / <sub>16</sub> " X 2 <sup>13</sup> / <sub>16</sub> " X 1 <sup>3</sup> / <sub>8</sub> "	x 1	F2	 56 <sup>3</sup> / <sub>16</sub> " X 2 <sup>13</sup> / <sub>16</sub> " X 1 <sup>3</sup> / <sub>8</sub> "	x 1
F3	 42 <sup>1</sup> / <sub>8</sub> " X 2 <sup>13</sup> / <sub>16</sub> " X 1 <sup>3</sup> / <sub>8</sub> "	x 1	G1	 57 <sup>9</sup> / <sub>16</sub> " X 2 <sup>3</sup> / <sub>8</sub> " X 1 <sup>3</sup> / <sub>8</sub> "	x 1	G2	 57 <sup>9</sup> / <sub>16</sub> " X 2 <sup>3</sup> / <sub>8</sub> " X 1 <sup>3</sup> / <sub>8</sub> "	x 1
G3	 44 <sup>7</sup> / <sub>8</sub> " X 2 <sup>3</sup> / <sub>8</sub> " X 1 <sup>3</sup> / <sub>8</sub> "	x 1	H1	 57 <sup>9</sup> / <sub>16</sub> " X 2 <sup>3</sup> / <sub>8</sub> " X 1 <sup>3</sup> / <sub>8</sub> "	x 10	H2	 44 <sup>7</sup> / <sub>8</sub> " X 2 <sup>3</sup> / <sub>8</sub> " X 1 <sup>3</sup> / <sub>8</sub> "	x 5
J1	 87 <sup>5</sup> / <sub>16</sub> " X 3 <sup>9</sup> / <sub>16</sub> " X 1 <sup>3</sup> / <sub>8</sub> "	x 2	J2	 73 <sup>1</sup> / <sub>18</sub> " X 3 <sup>9</sup> / <sub>16</sub> " X 1 <sup>3</sup> / <sub>8</sub> "	x 2	K1	 46 <sup>1</sup> / <sub>4</sub> " X 10 <sup>3</sup> / <sub>8</sub> " X 3 <sup>5</sup> / <sub>8</sub> "	x 2
K2	 44 <sup>7</sup> / <sub>8</sub> " X 10 <sup>3</sup> / <sub>8</sub> " X 3 <sup>5</sup> / <sub>8</sub> "	x 1	L1	 67 <sup>5</sup> / <sub>16</sub> " X 34 <sup>5</sup> / <sub>8</sub> " X 1 <sup>3</sup> / <sub>16</sub> "	x 5	L2	 67 <sup>5</sup> / <sub>16</sub> " X 34 <sup>5</sup> / <sub>8</sub> " X 1 <sup>3</sup> / <sub>16</sub> "	x 5
W	 2 <sup>3</sup> / <sub>8</sub> " X 2 <sup>3</sup> / <sub>8</sub> " X 81 <sup>1</sup> / <sub>2</sub> "	x 4						









# PRÉASSEMBLAGE / PRE-ASSEMBLY

## Liste des pièces (2) / Parts List (2)

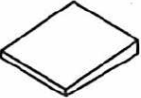
Pièce/ Part	Description	Qté / Qty	Pièce/ Part	Description	Qté / Qty	Pièce/ Part	Description	Qté / Qty
W1-3		x 8	W3-1		x 4	W3-2		x 4
	16 <sup>15/16"</sup> X 2 <sup>3/8"</sup> X 81 <sup>7/8"</sup>			12" X 2 <sup>3/8"</sup> X 81 <sup>7/8"</sup>			12" X 2 <sup>3/8"</sup> X 81 <sup>7/8"</sup>	
W6		x 1	W7		x 1	W8		x 1
	72 <sup>7/16"</sup> X 2 <sup>9/16"</sup> X 2 <sup>9/16"</sup>			72 <sup>7/16"</sup> X 2 <sup>9/16"</sup> X 2 <sup>9/16"</sup>			78 <sup>9/16"</sup> X 2 <sup>9/16"</sup> X 2 <sup>9/16"</sup>	
W9		x 1	W10		x 1	W11		x 1
	78 <sup>9/16"</sup> X 2 <sup>9/16"</sup> X 2 <sup>9/16"</sup>			33 <sup>7/8"</sup> X 1 <sup>3/4"</sup> X 74 <sup>3/8"</sup>			33 <sup>7/8"</sup> X 1 <sup>3/4"</sup> X 74 <sup>3/8"</sup>	
W12		x 1	W13		x 2	W14		x 3
	74 <sup>3/4"</sup> X 2 <sup>3/8"</sup> X 3 <sup>1/2"</sup>			2 <sup>3/8"</sup> X 1 <sup>3/8"</sup> X 78 <sup>3/8"</sup>			76" X 64 <sup>1/8"</sup> X 3 <sup>3/8"</sup>	
W15		x 3	T10-1		x 40	T11		x 2
	75 <sup>3/4"</sup> X 18 <sup>7/8"</sup> X 2 <sup>3/8"</sup>			3/16" X 3 <sup>1/8"</sup>				
T12		x 1	T13		x 2	T14		x 1
T15		x 4	T16		x 20	T17		x 22
U1		x 8	U2		x 28	U3		x 174
	3/16" X 3 <sup>9/16"</sup>			3/16" X 3"			3/16" X 2 <sup>3/16"</sup>	
U4		x 98	U5		x 88	U7-1		x 4
	3/16" X 1 <sup>3/16"</sup>			3/16" X 2 <sup>3/16"</sup>			3/16" X 13/16"	

# PRÉASSEMBLAGE / PRE-ASSEMBLY

Liste des pièces (3) / Parts List (3)

Pièce/ Part	Description	Qté / Qty	Pièce/ Part	Description	Qté / Qty	Pièce/ Part	Description	Qté / Qty
U8		x 12	U9		x 70	U10		x 82
	3/16" X 2 <sup>3/16"</sup>			3/16" X 1 <sup>3/16"</sup>			3/16" X 2 <sup>1/2"</sup>	
V		x 15	V1		x 44	V2		x 4
	Cale / Shim			Cale d'espacement en plastique / Plastic spacer piece				
V3		x 4	X		x 1	X1		x 2

# ASSEMBLAGE / ASSEMBLY

Étape / Step 1

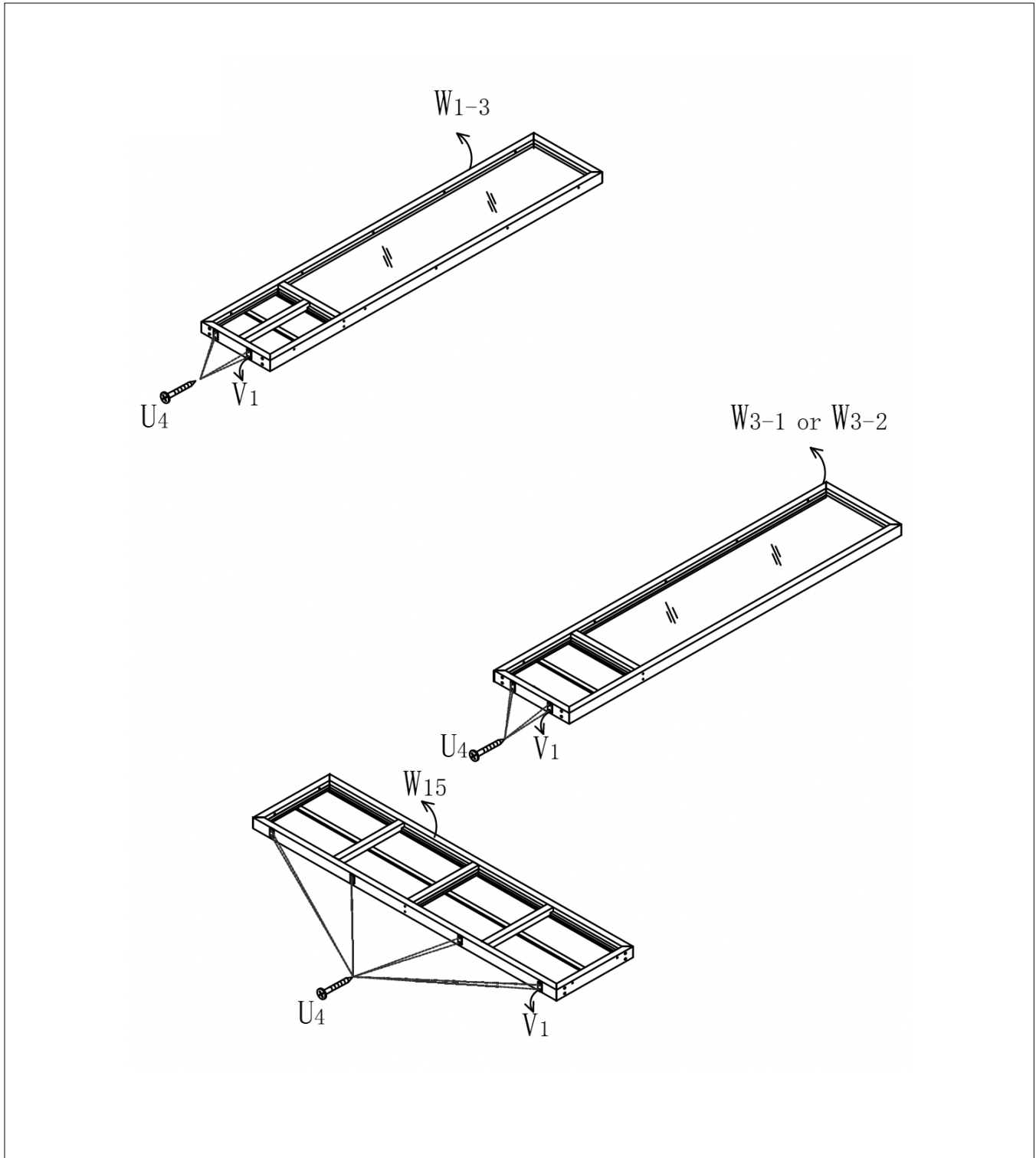

# ASSEMBLAGE / ASSEMBLY

## Étape / Step 2

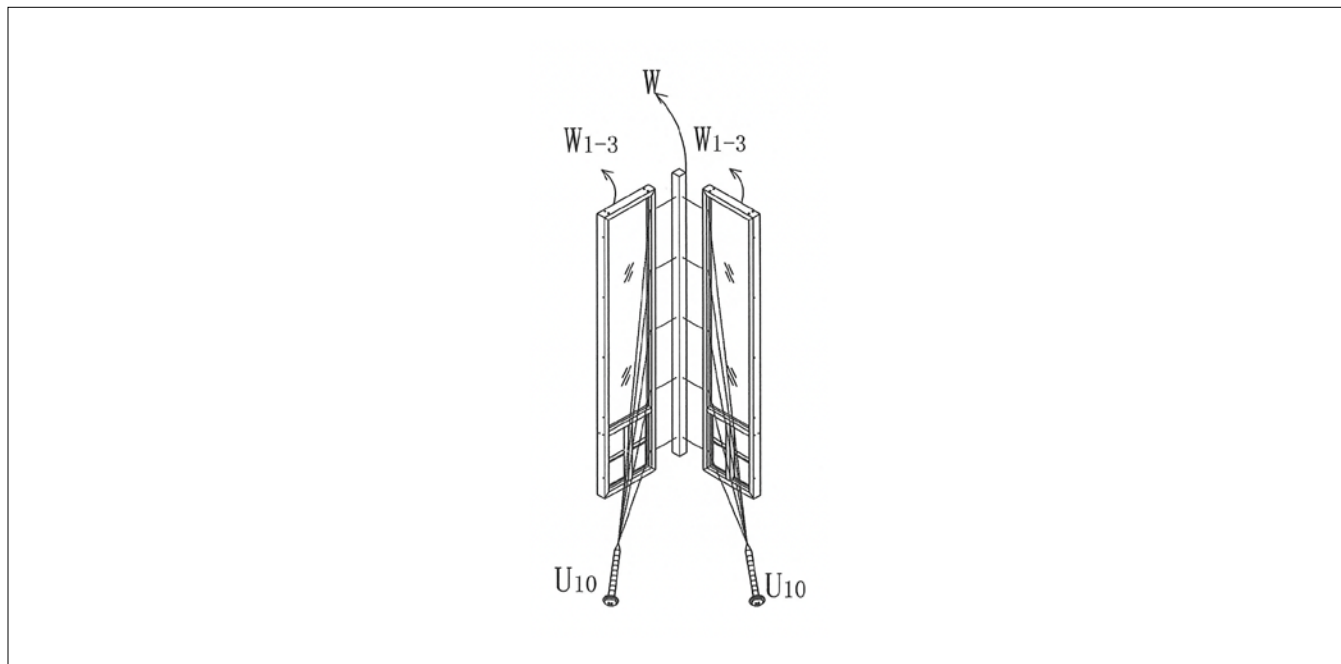

## Étape / Step 3

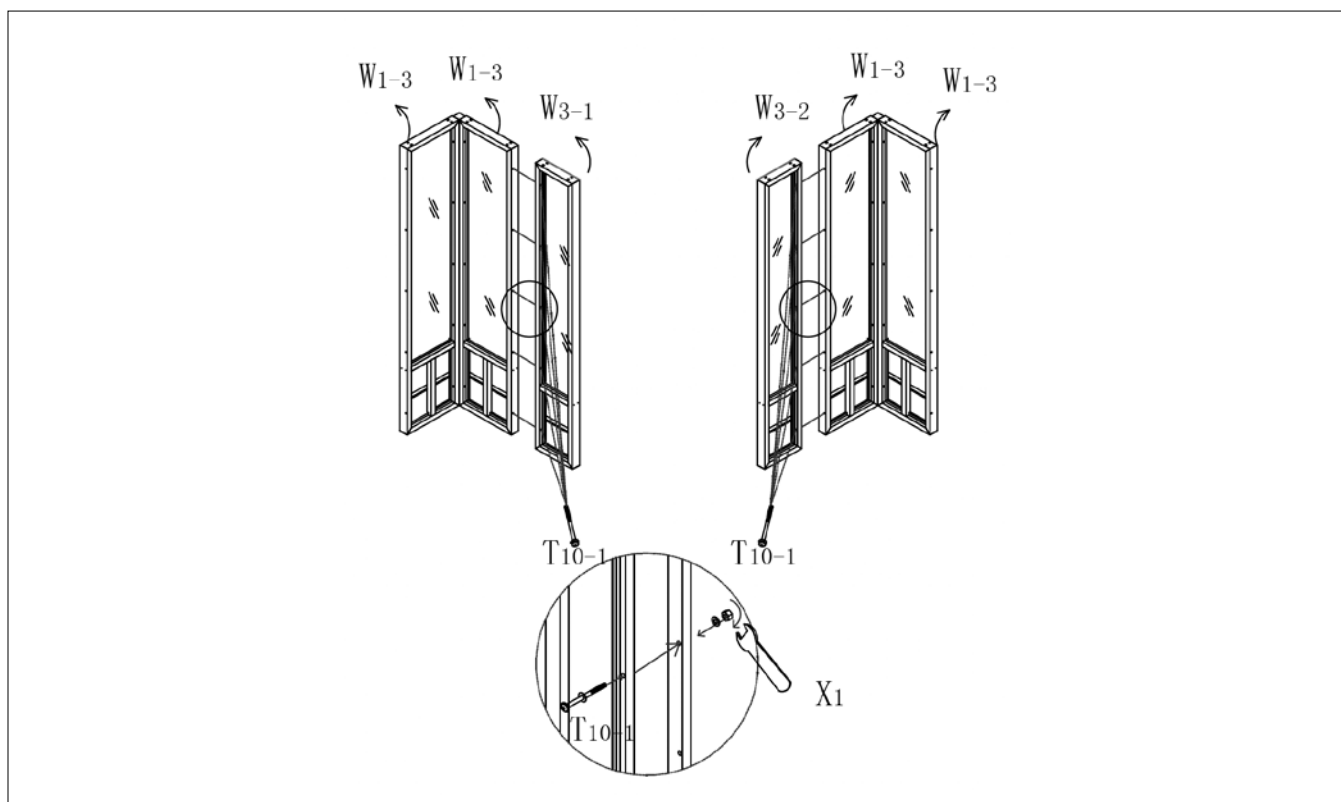

# ASSEMBLAGE / ASSEMBLY

## Étape / Step 4

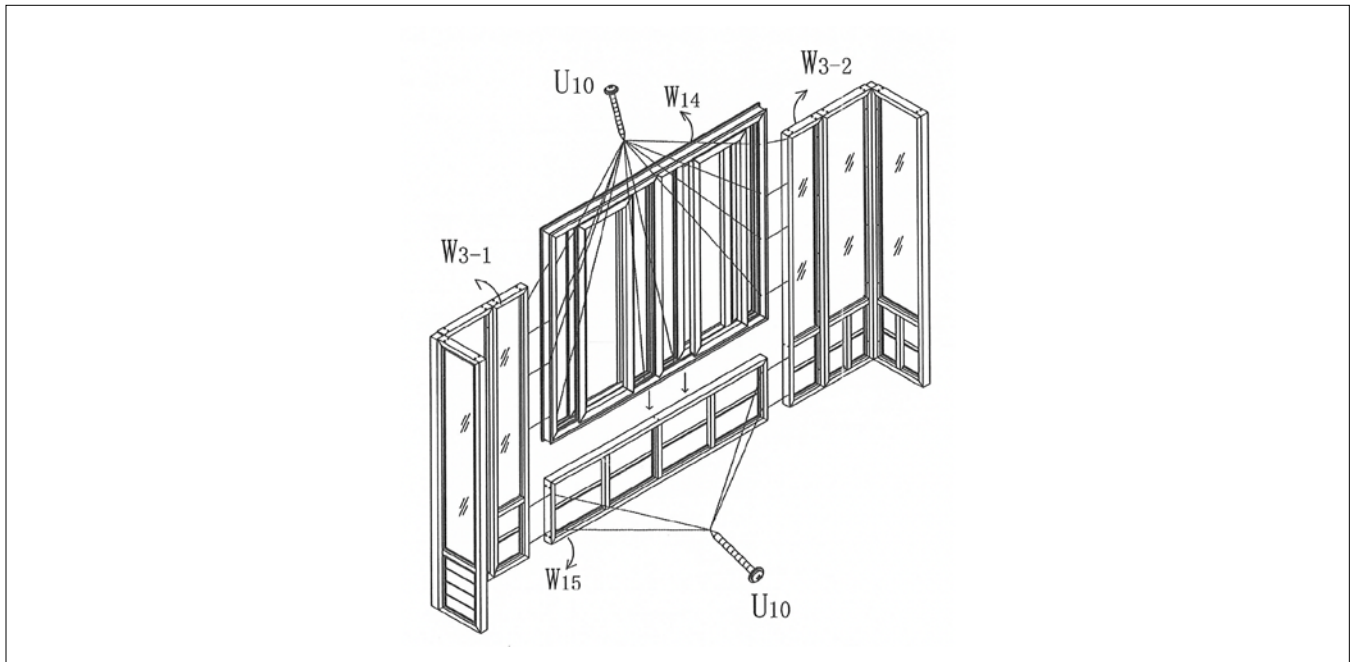

## Étape / Step 5

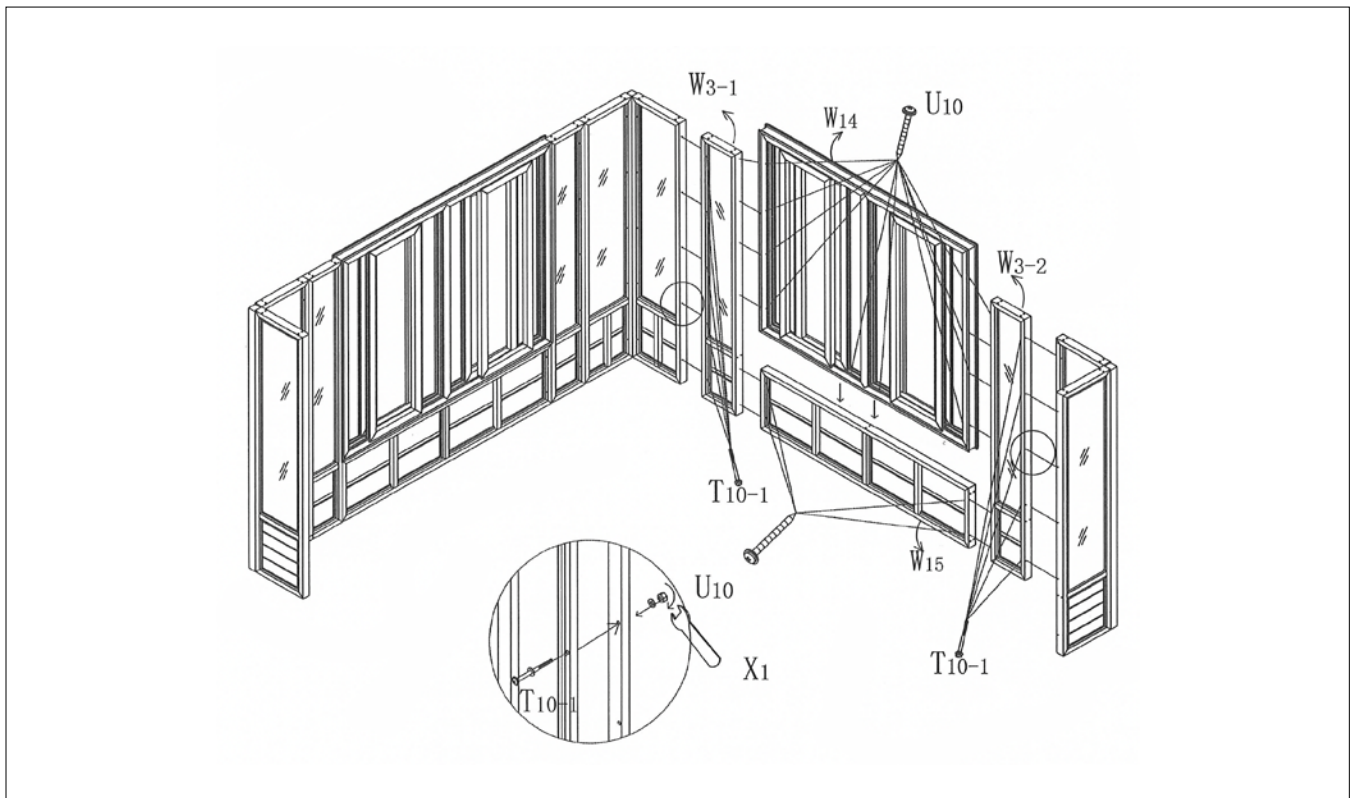

# ASSEMBLAGE / ASSEMBLY

## Étape / Step 6

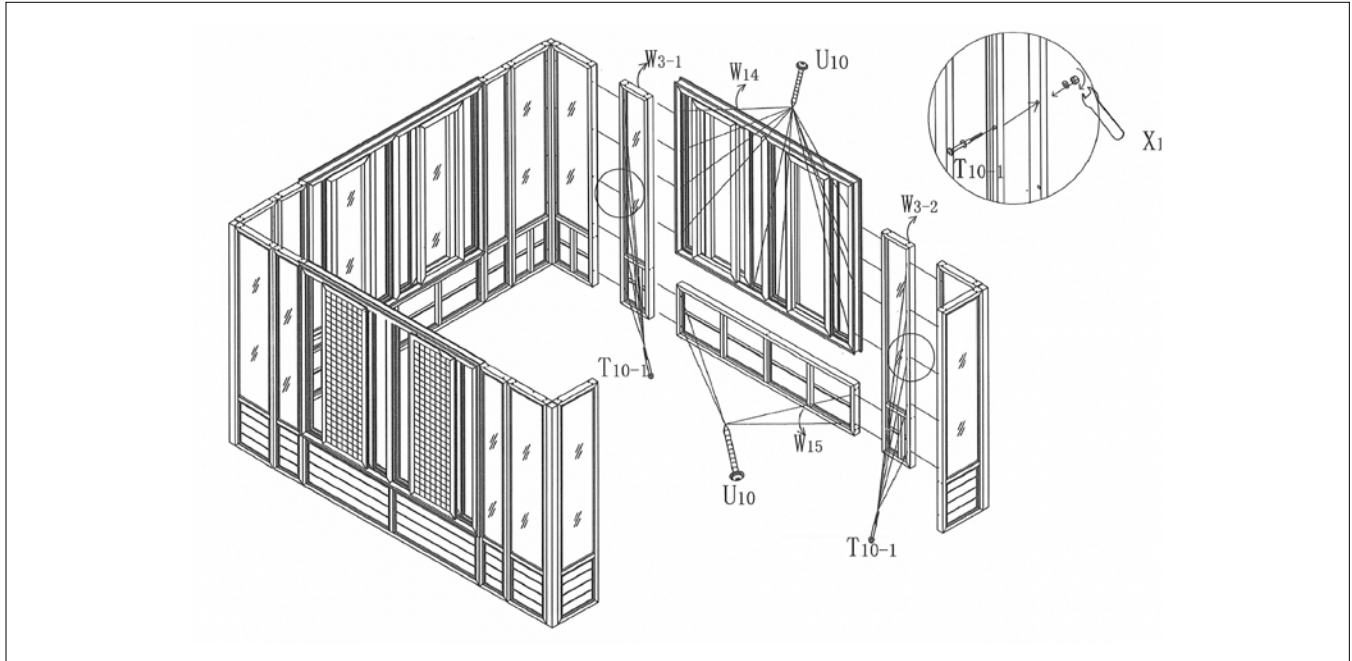

## Étape / Step 7

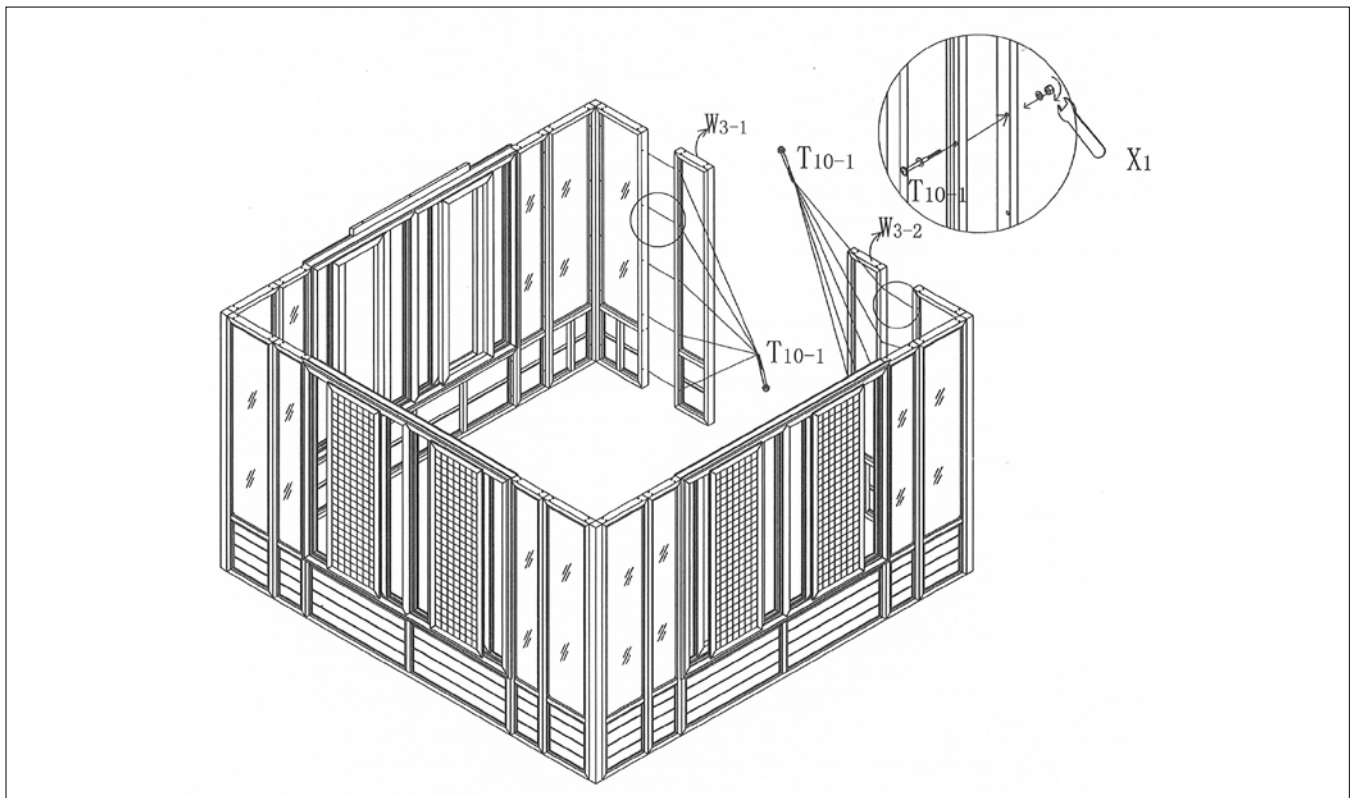



# ASSEMBLAGE / ASSEMBLY

## Étape / Step 8

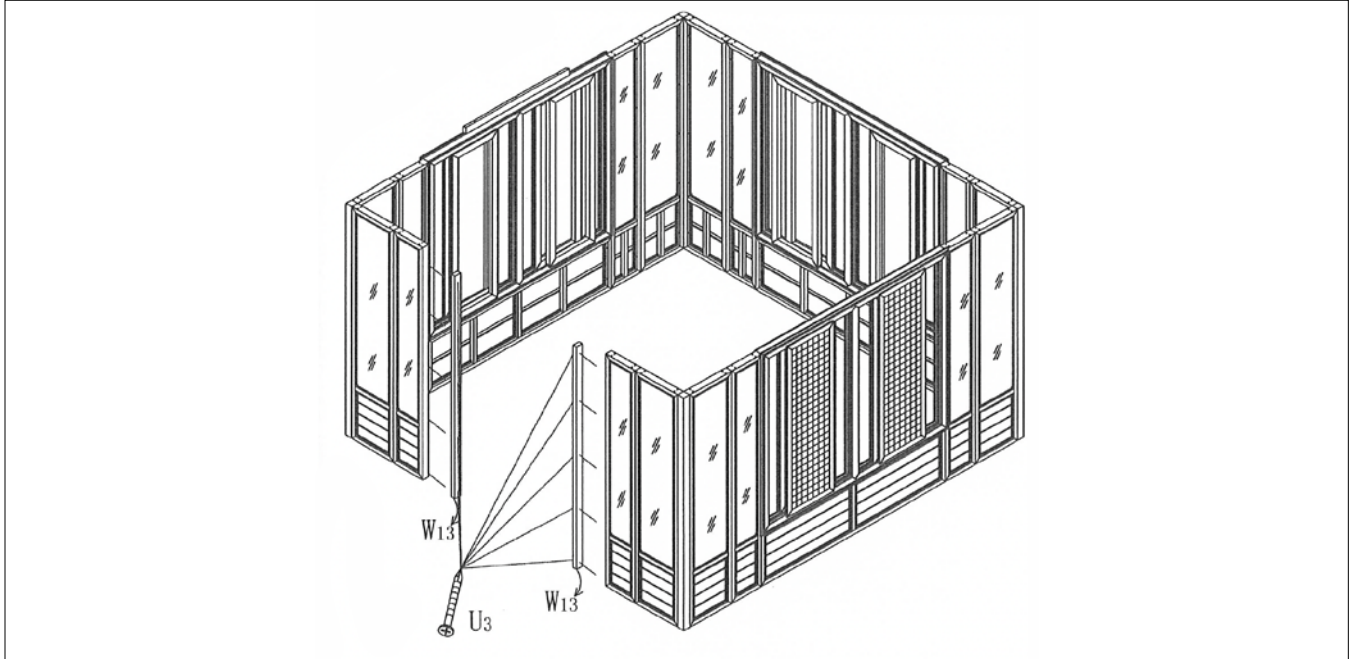

## Étape / Step 9

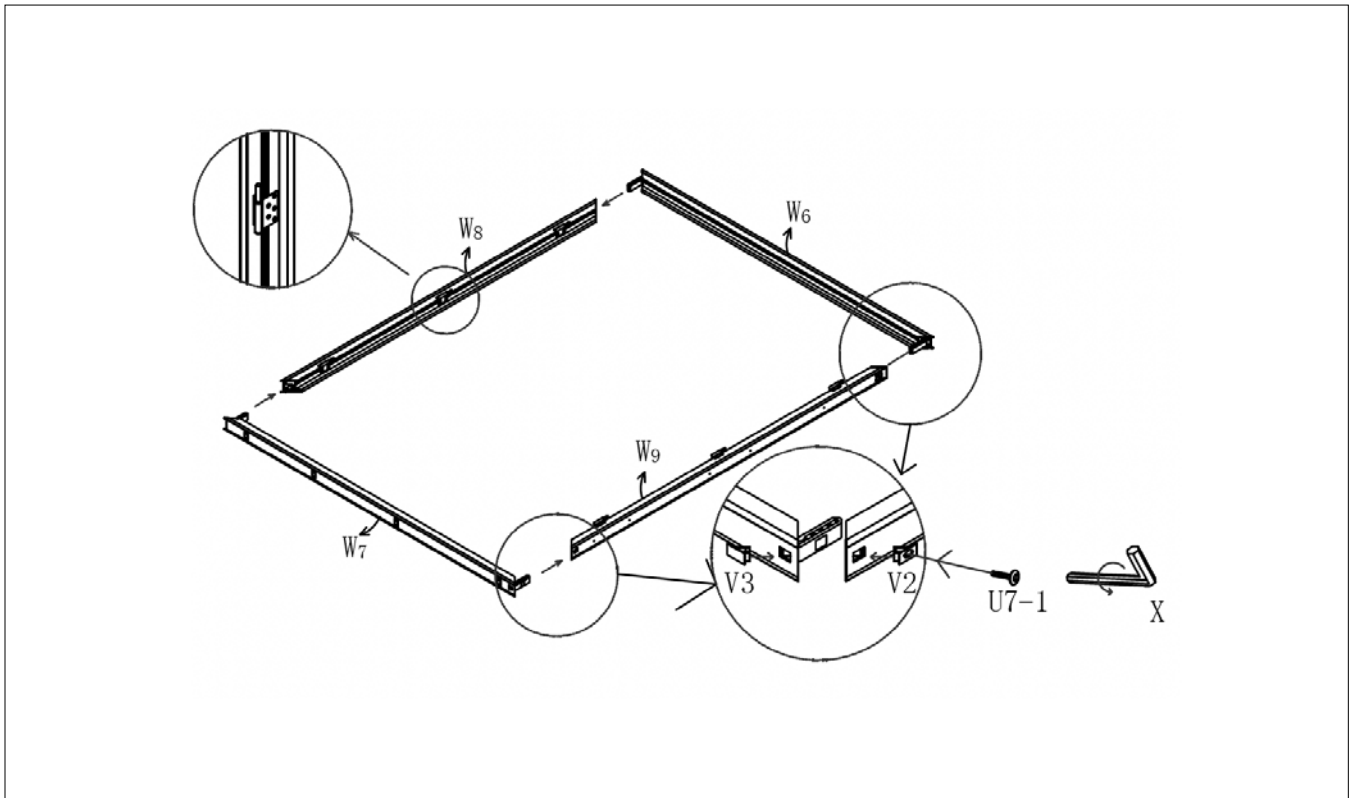

# ASSEMBLAGE / ASSEMBLY

## Étape / Step 10

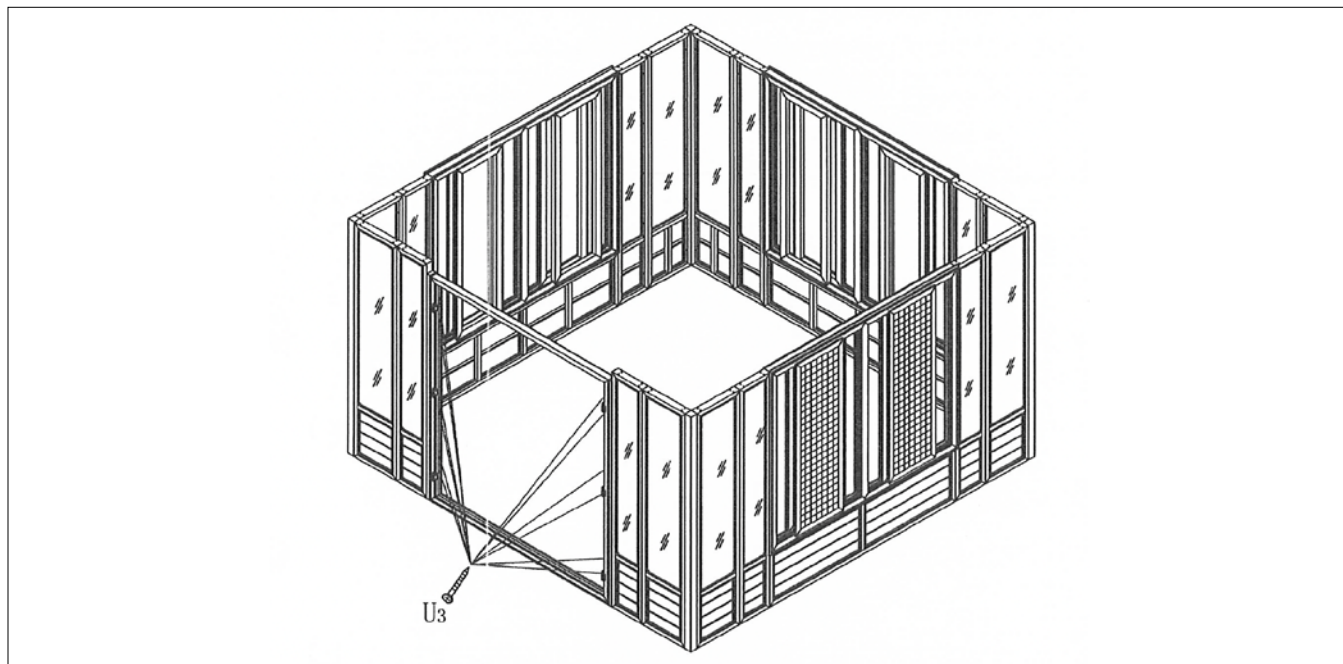

## Étape / Step 11

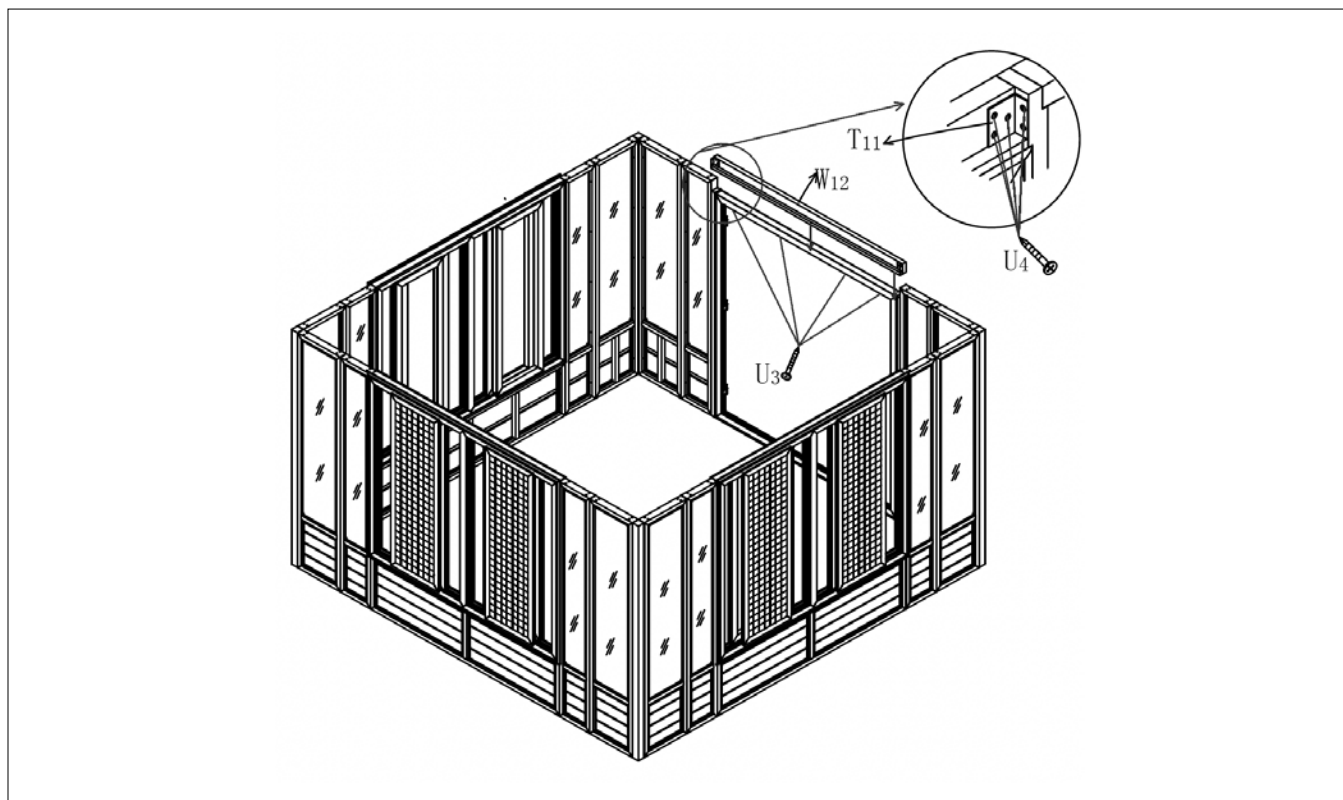

# ASSEMBLAGE / ASSEMBLY

## Étape / Step 12

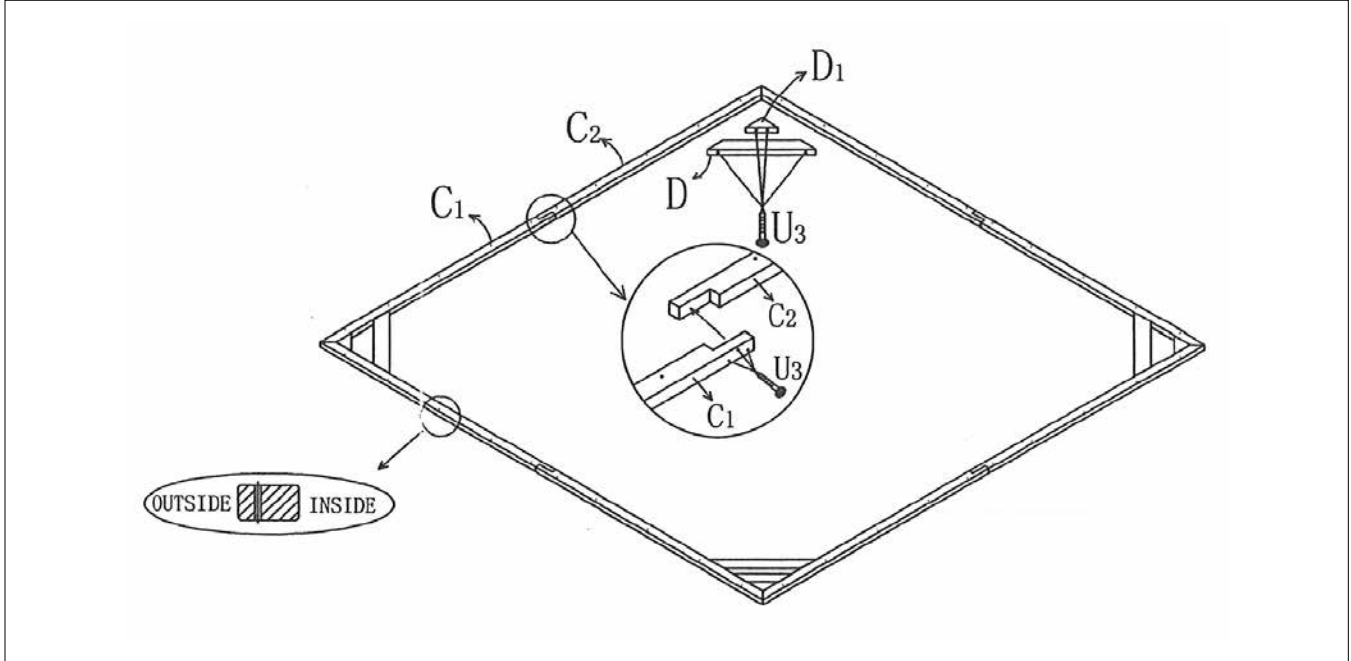

## Étape / Step 13

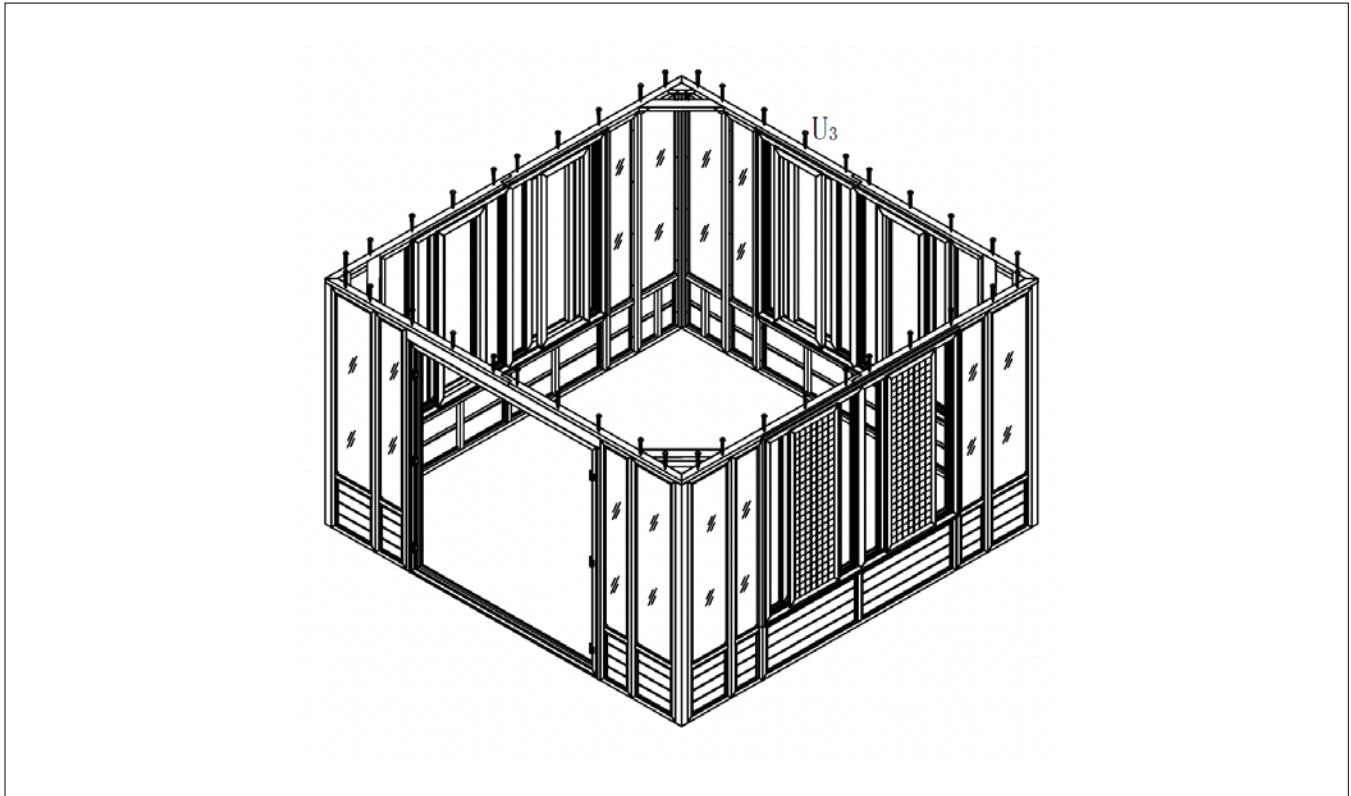

# ASSEMBLAGE / ASSEMBLY

Étape / Step 14

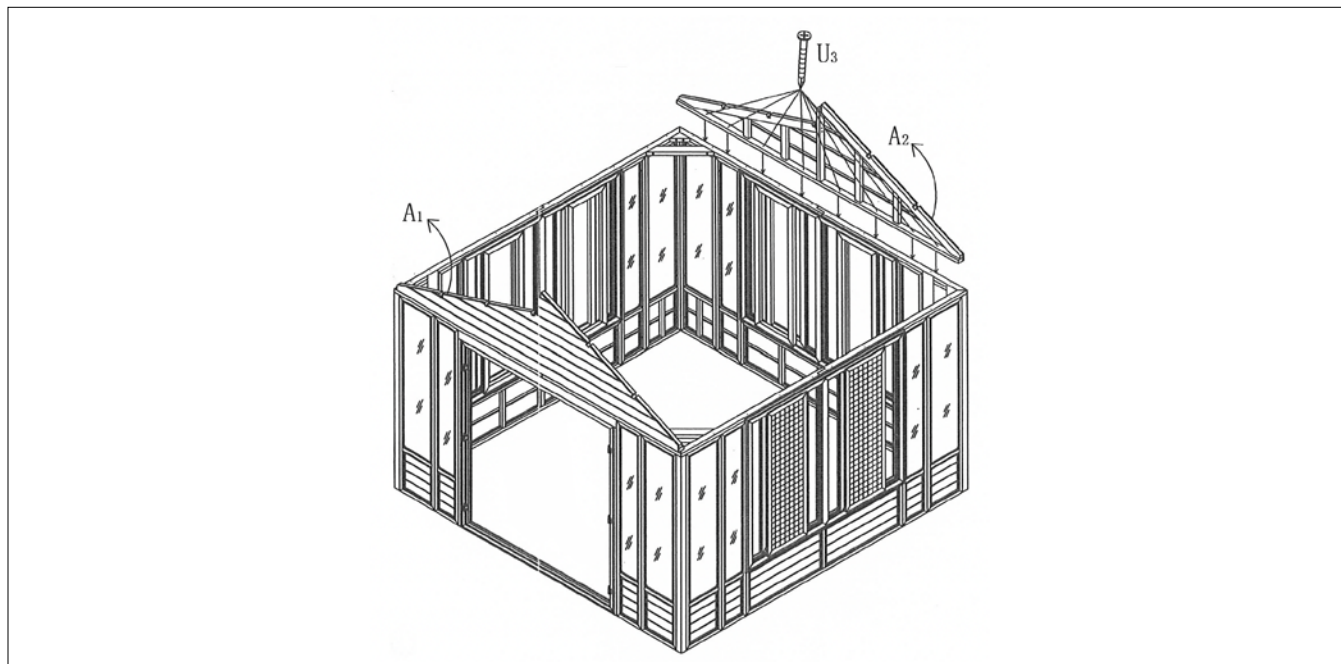

Étape / Step 15

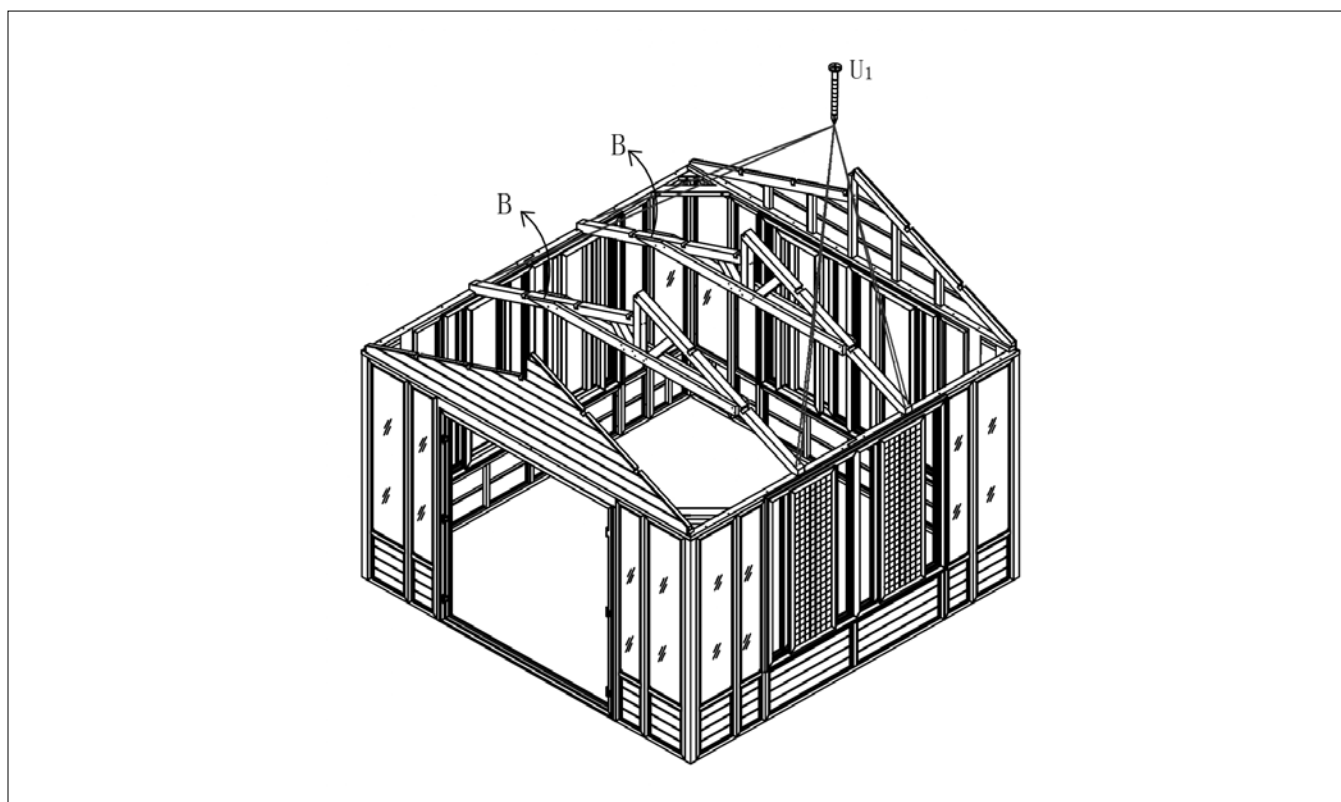

# ASSEMBLAGE / ASSEMBLY

## Étape / Step 16

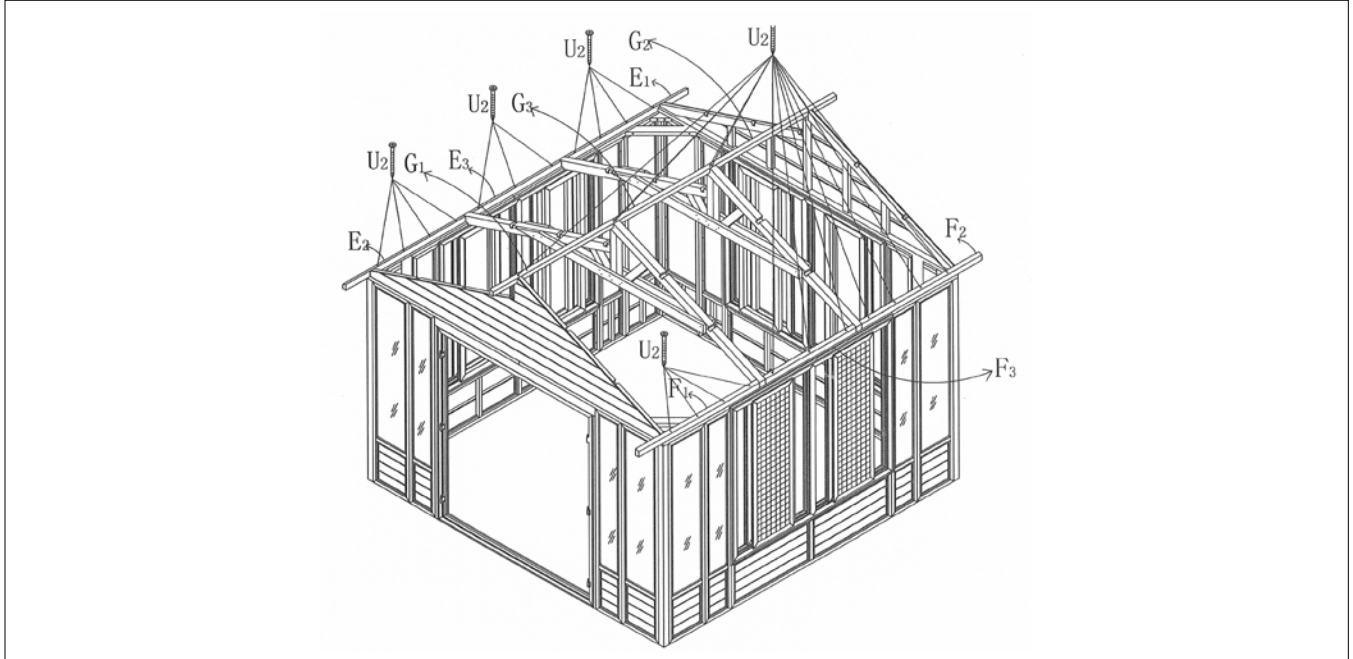

## Étape / Step 17

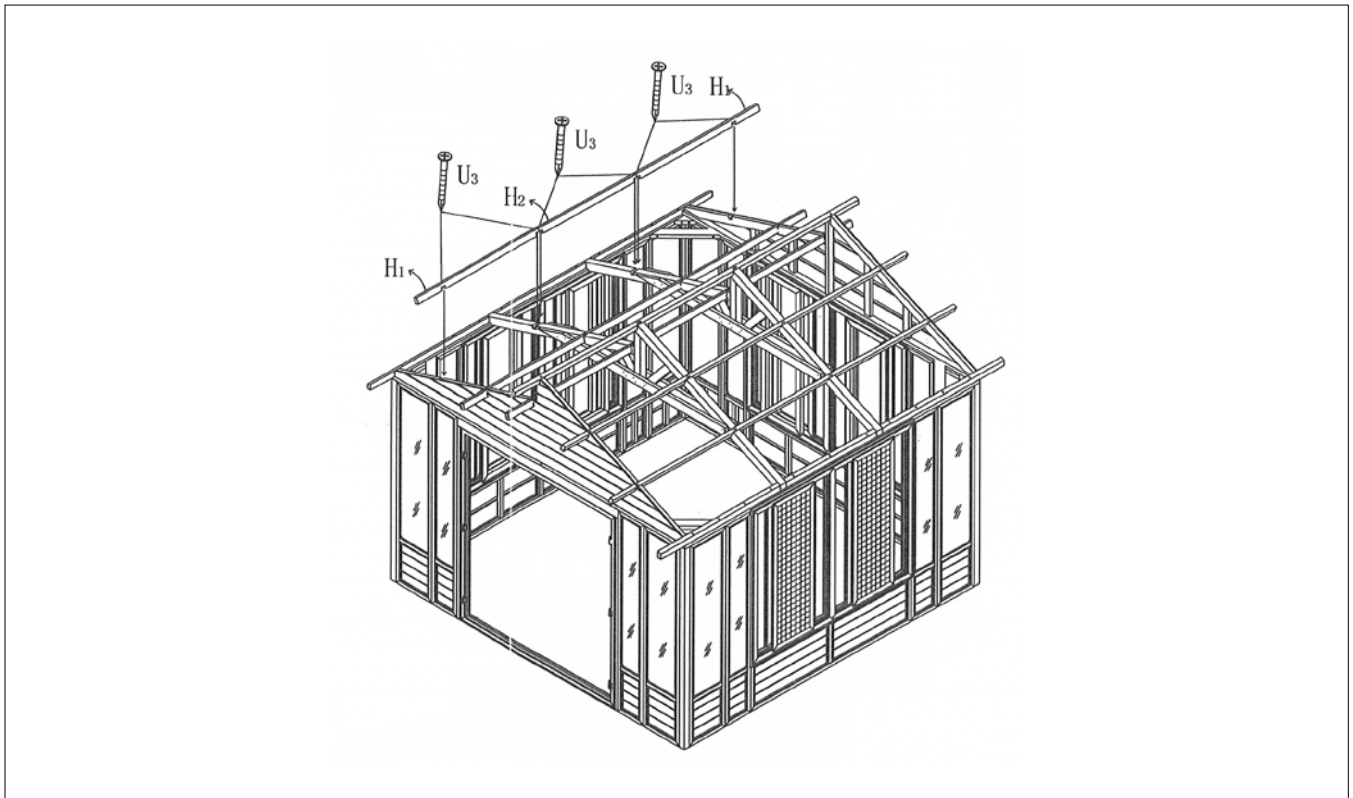

# ASSEMBLAGE / ASSEMBLY

## Étape / Step 18

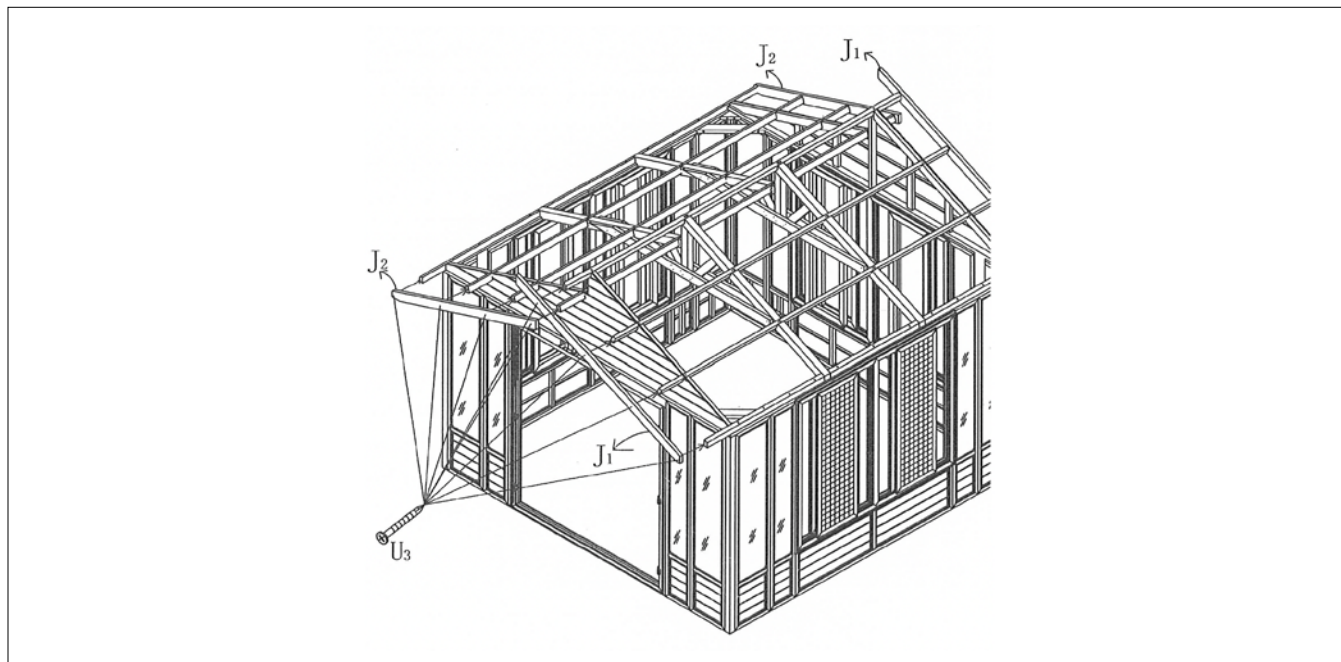

## Étape / Step 19

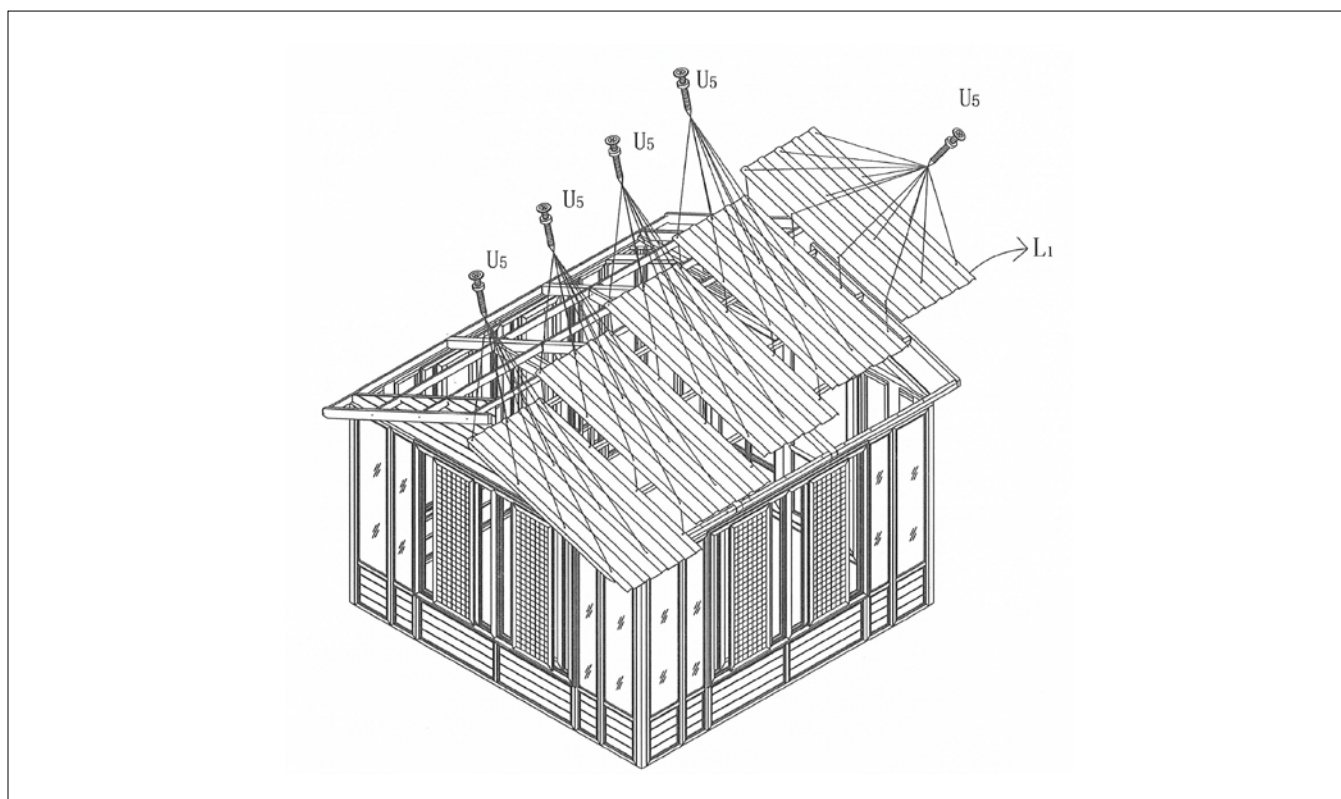

# ASSEMBLAGE / ASSEMBLY

Étape / Step 20

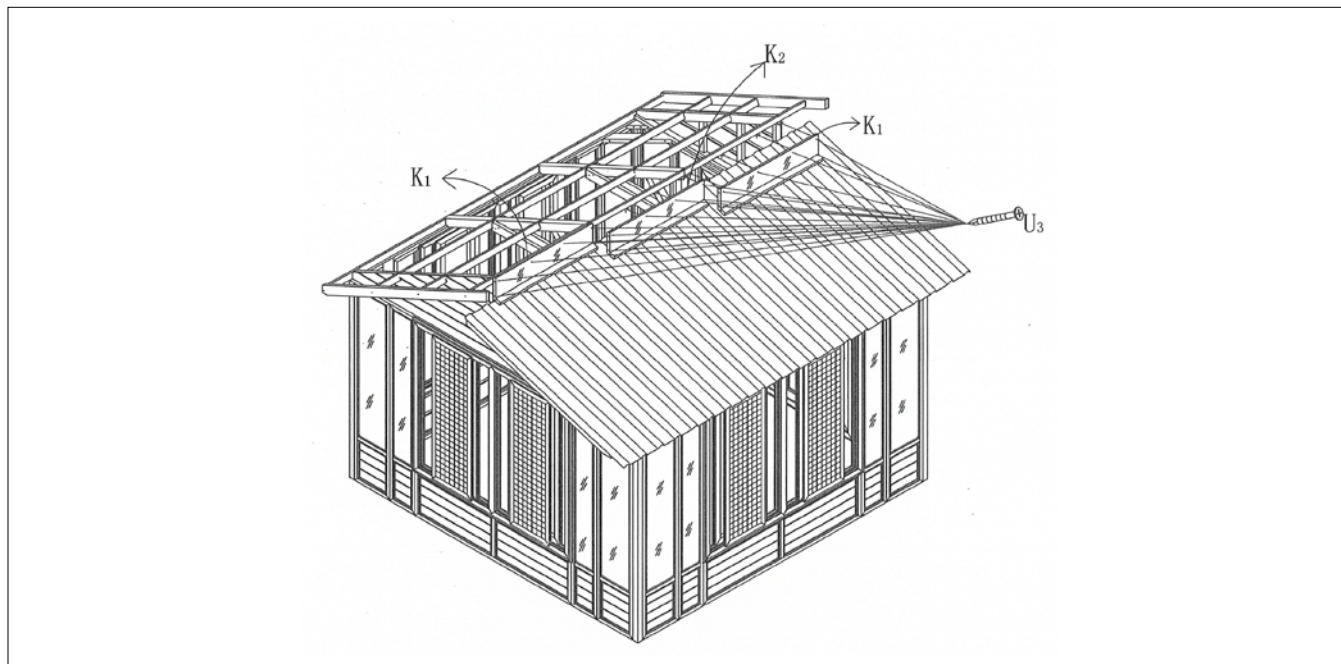

Étape / Step 21

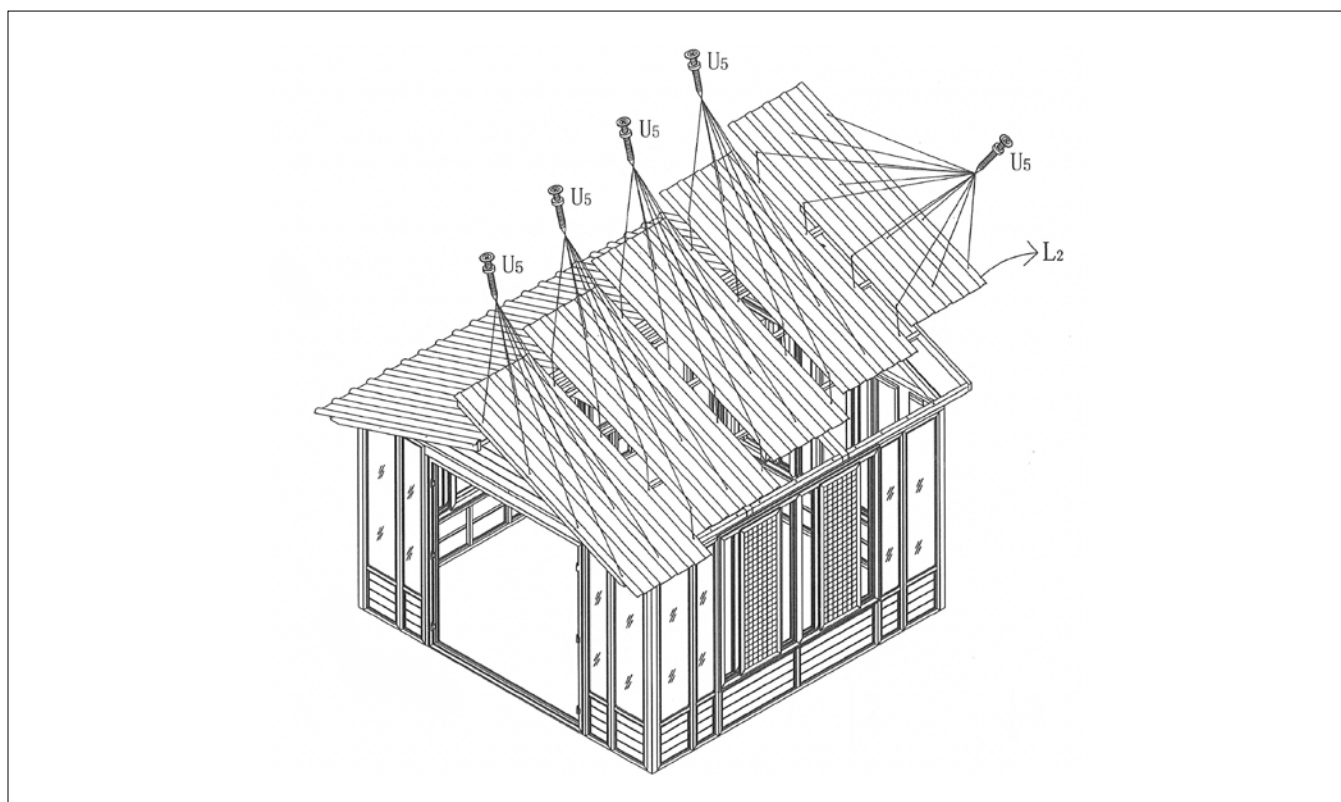

# ASSEMBLAGE / ASSEMBLY

Étape / Step 22

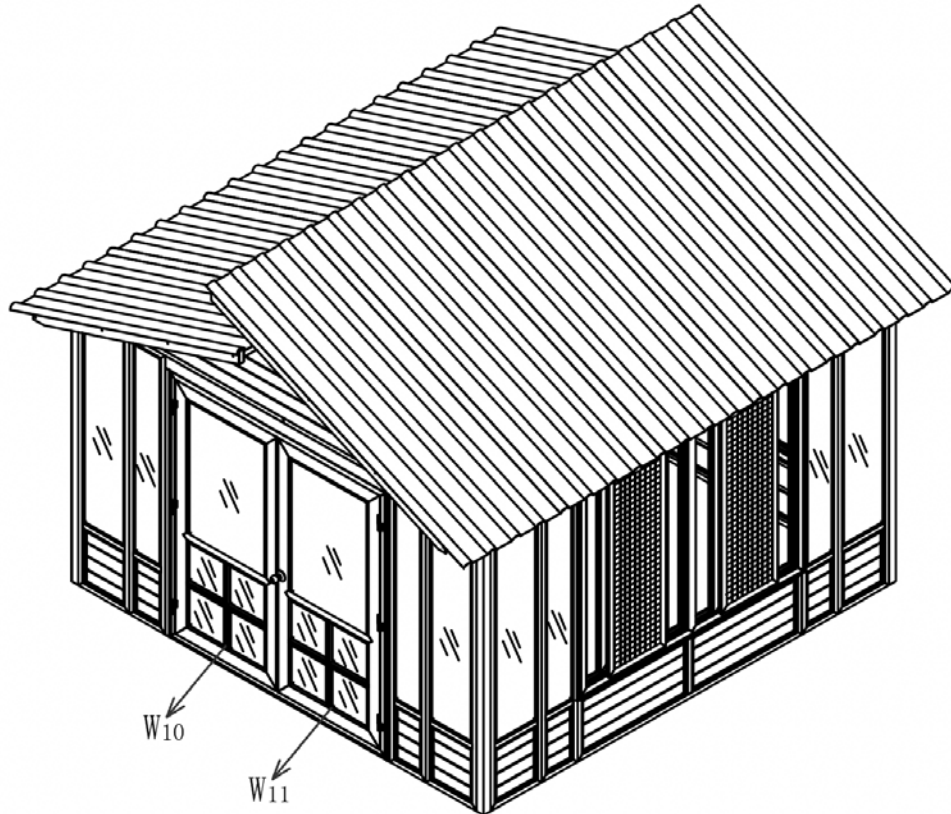

Installez l'ensemble poignée et serrure.  
Install handle/lock assembly.

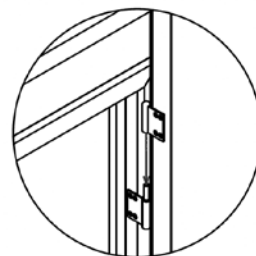

Installez les cales pour assurer un bon fonctionnement.

Install shims for smooth operation.

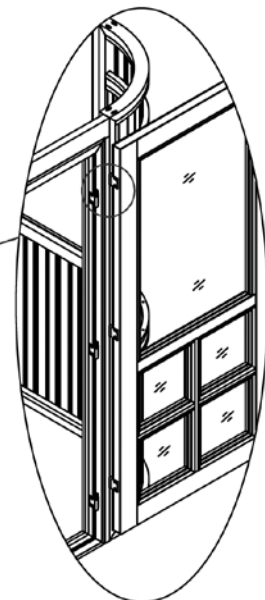



# ASSEMBLAGE / ASSEMBLY

## Étape / Step 22 (2)

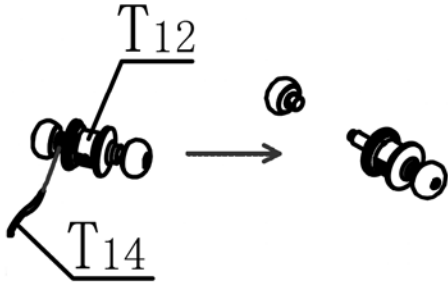

ÉTAPE 1: Installation de la serrure de porte.  
Retirez la poignée de serrure de porte en appuyant sur le bouton.

STEP 1: Door Lock Installation.  
Remove the door lock handle by pressing the knob.

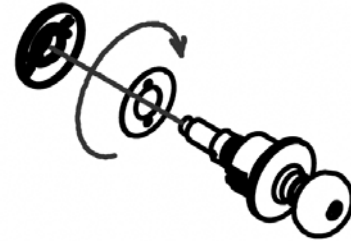

ÉTAPE 2: Retirez la rosette et la bague intérieure de la serrure de porte.

STEP 2: Remove the door lock cover and inner lock ring.

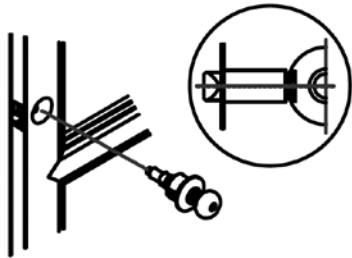

ÉTAPE 3: Installation de la poignée de serrure de porte.  
Installez la poignée de serrure de porte dans l'orifice de la porte et verrouillez l'extrémité de la poignée de porte.

STEP 3: Door Lock Handle Installation.  
Install the door lock handle into the door hole and lock the end part of the door handle.

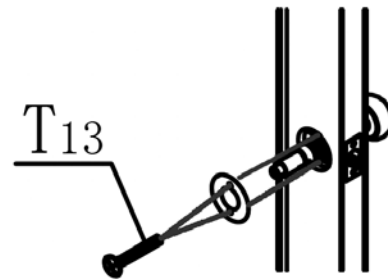

ÉTAPE 4: Installez la bague intérieure de la serrure de porte avec une vis tel qu'indiqué.

STEP 4: Install the door lock inner ring with a screw as shown.

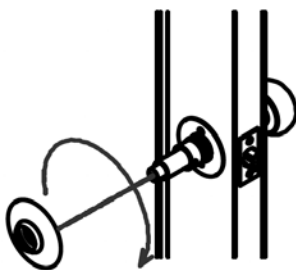

ÉTAPE 5: Installation de la rosette de serrure de porte.  
STEP 5: Door Lock Cover Ring Installation.

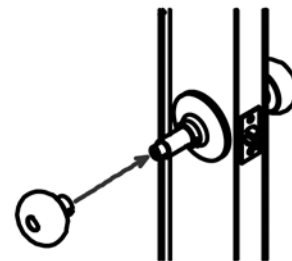

ÉTAPE 6: Installation de la poignée de serrure de porte.  
STEP 6: Door lock handle installation.

# ASSEMBLAGE / ASSEMBLY

## Étape / Step 23

