



PAVILLON TREVISO 13' X 17'

13' x 17' Treviso Pavillon

GUIDE D'ASSEMBLAGE

Assembly Instructions

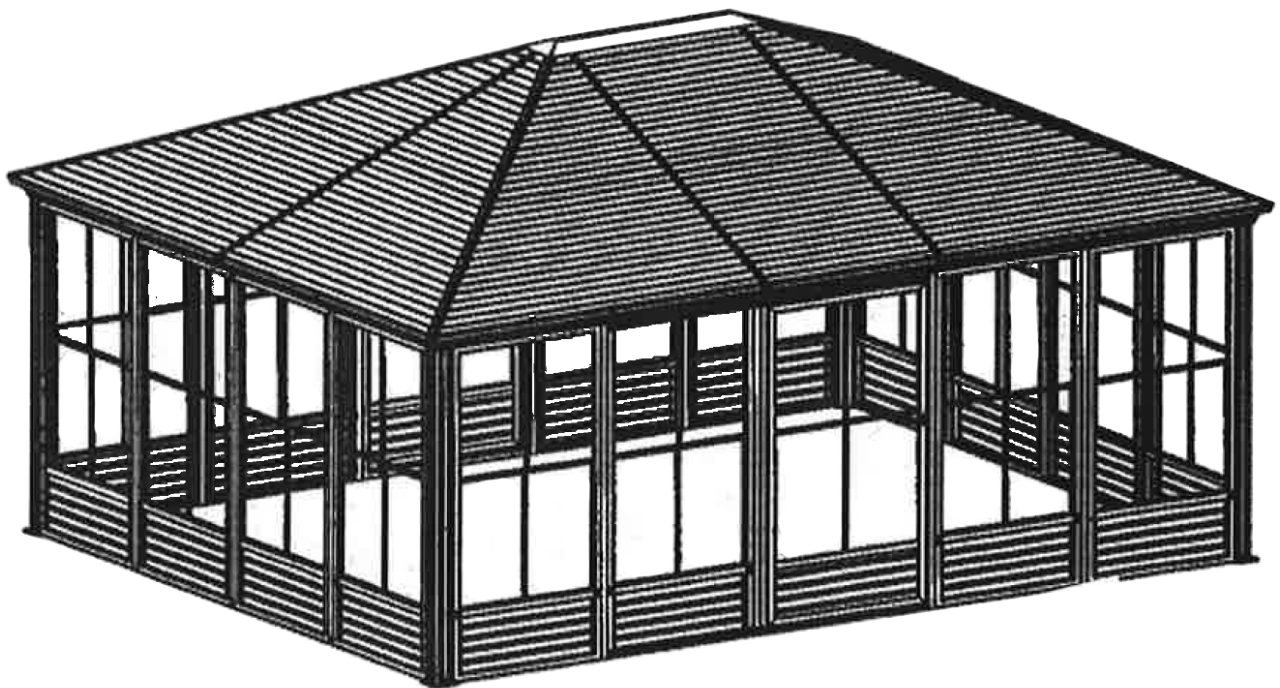







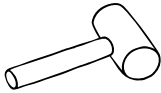

POUR TOUTE ASSISTANCE,
CONTACTEZ VOTRE DÉTAILLANT.
For assistance, contact your retailer.









Fabriqué en Chine / Made in China

PRÉASSEMBLAGE / PRE-ASSEMBLY

Outils requis (Non inclus à l'intérieur des boîtes) / Tools required (Not included in boxes)







				
Niveau Level	Maillet en caoutchouc Rubber mallet	Tournevis étoile Phillips screw driver	Perceuse Drill	Clé Allen 5/32" Allen Key 5/32"
				
Clé Allen 7/32" Allen Key 7/32"	Casque de sécurité Safety hat	Gants Gloves	Lunettes de sécurité Safety goggles	Escabeau Step ladder

Trousse de quincaillerie incluse / Hardware package included

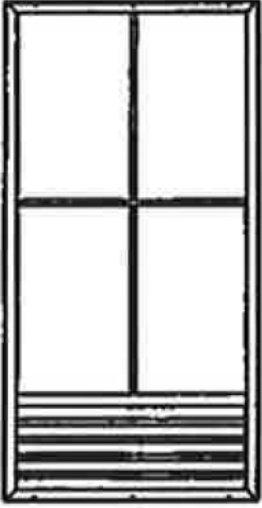
#1	 M 8 x 18	x 157	#2	 M 5 x 18	x 76
#3	 M 8 x 48	x 24	#4	 ST 4 x 16	x 16
#5	 ST 3.5 x 13	x 32	#6	 M 6 x 35	x 16
#7	 Clé Allen / Allen Key	x 1	#8	 Clé à molette / Wrench	x 1

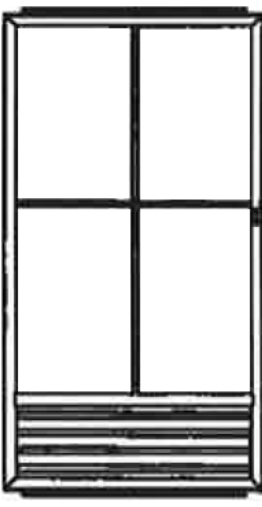





















PRÉASSEMBLAGE / PRE-ASSEMBLY

Liste des pièces (1) / Parts list (1)

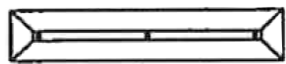
			
A	x 14	A1	x 2
			
B	x 2	B1	x 2
B2			x 2
B3			x 2
B4		x 8	B5
			x 2











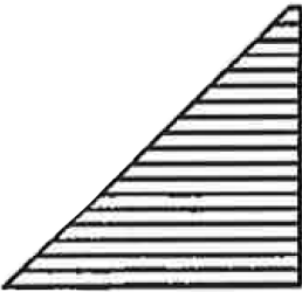

PRÉASSEMBLAGE / PRE-ASSEMBLY

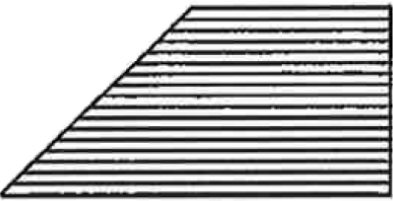
Liste des pièces (2) / Parts list (2)

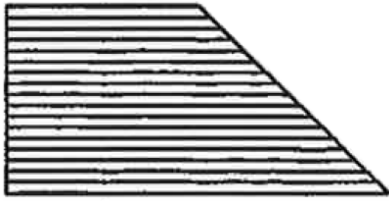
C						x 28
D		x 4	D1			x 4
E1						x 2
E2						x 2
E3						x 2
E4						x 2
E5						x 4
E6		x 4	E7			x 4
F1						x 2
F2						x 2
F3						x 2
F4						x 2
G		x 4	G1			x 6
H		x 1	H1			x 1
J		x 4	K			x 6
L						x 2
L1		x 4	L2			x 4

PRÉASSEMBLAGE / PRE-ASSEMBLY

Liste des pièces (2) / Parts list (2)

L3		x 4	L4		x 6
L5					x 8
					
P11	x 4	P33	x 2	P22	x 4
					
P1	x 4	P3	x 2	P2	x 4
Q					x 2
Q1					x 4
Q2					x 4
R		x 20			
S		x 4	T		x 6

ASSEMBLAGE / ASSEMBLY

Étape 1 / Step 1

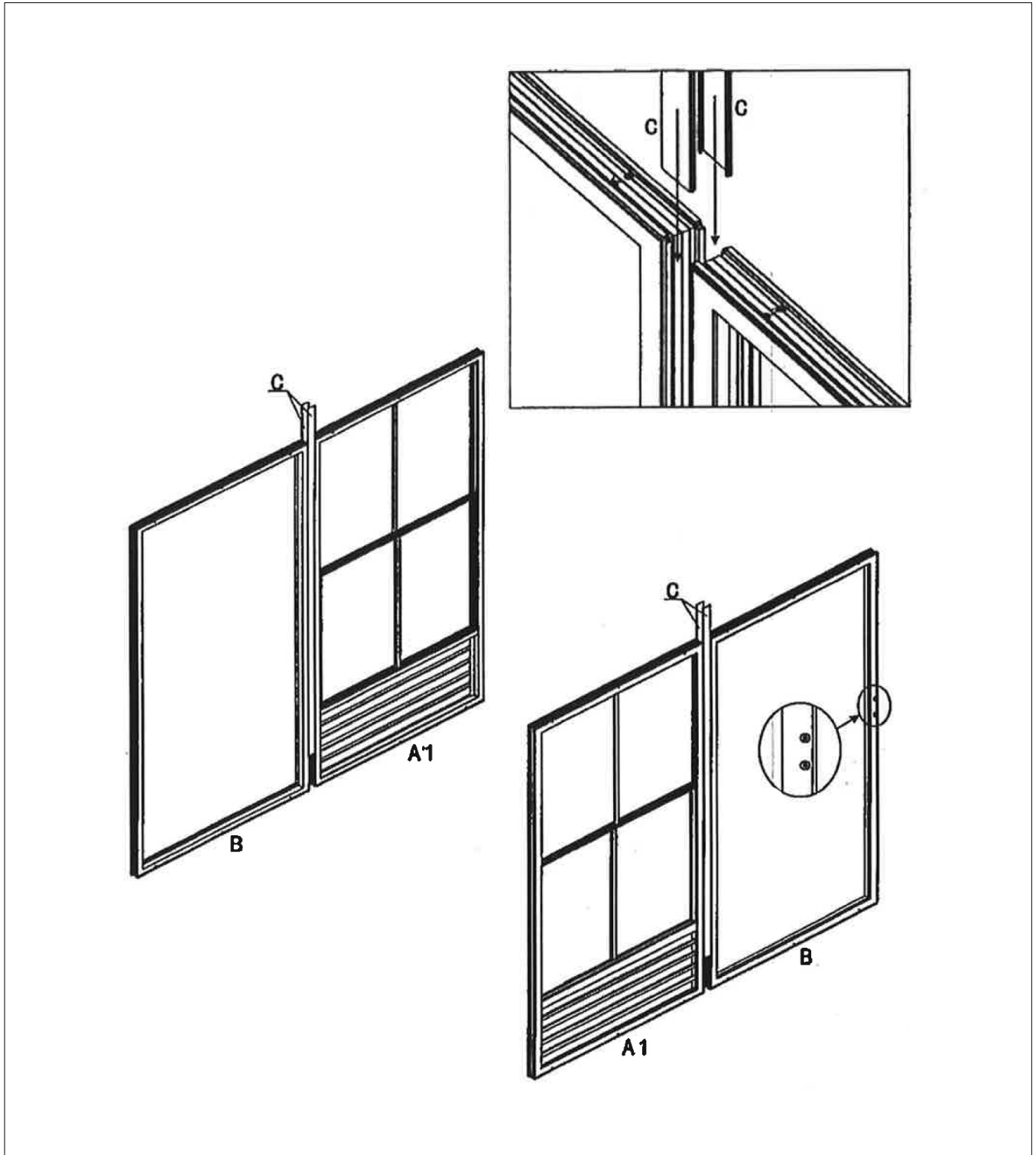

ASSEMBLAGE / ASSEMBLY

Étape 2 / Step 2

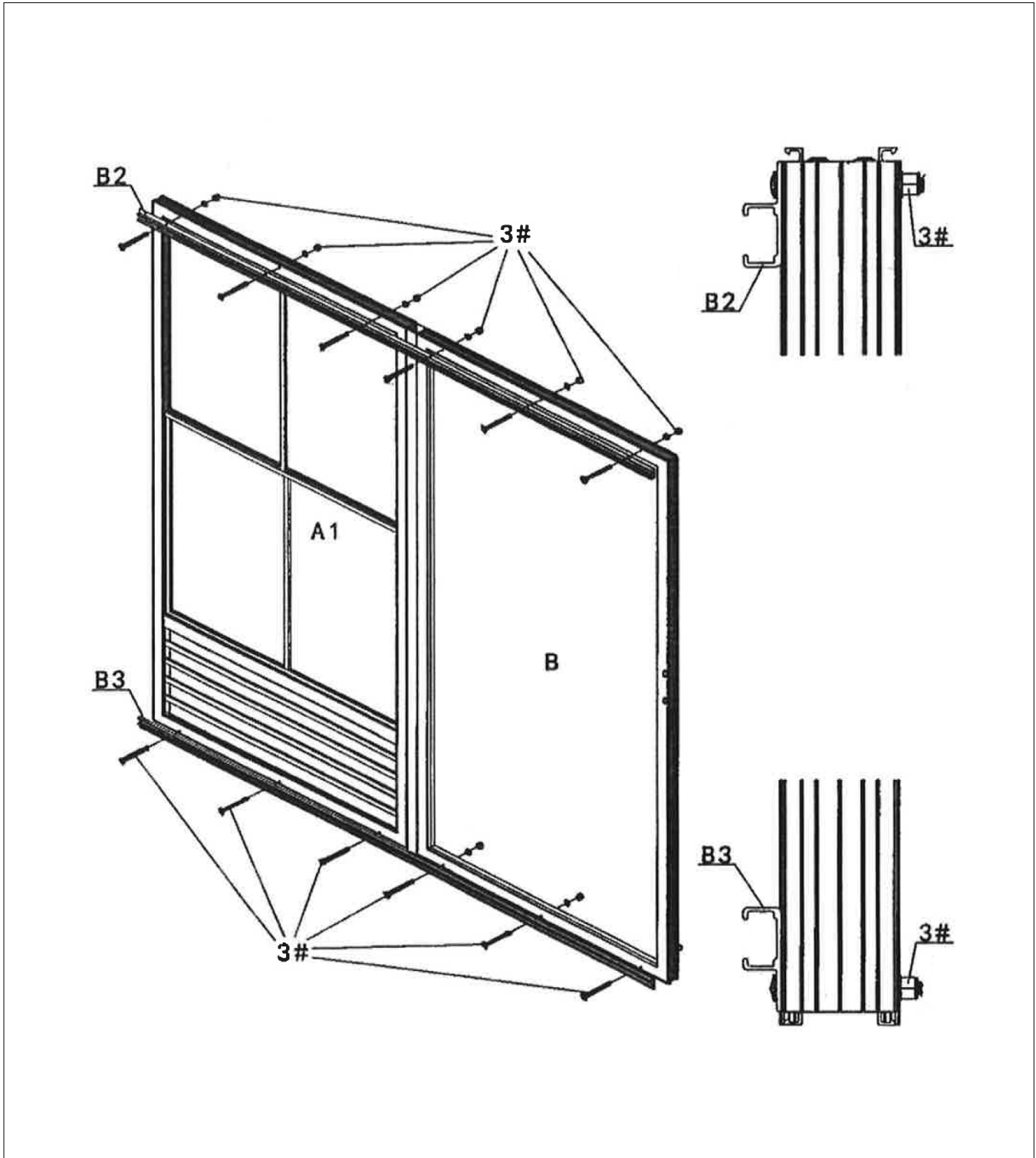

ASSEMBLAGE / ASSEMBLY

Étape 3 / Step 3

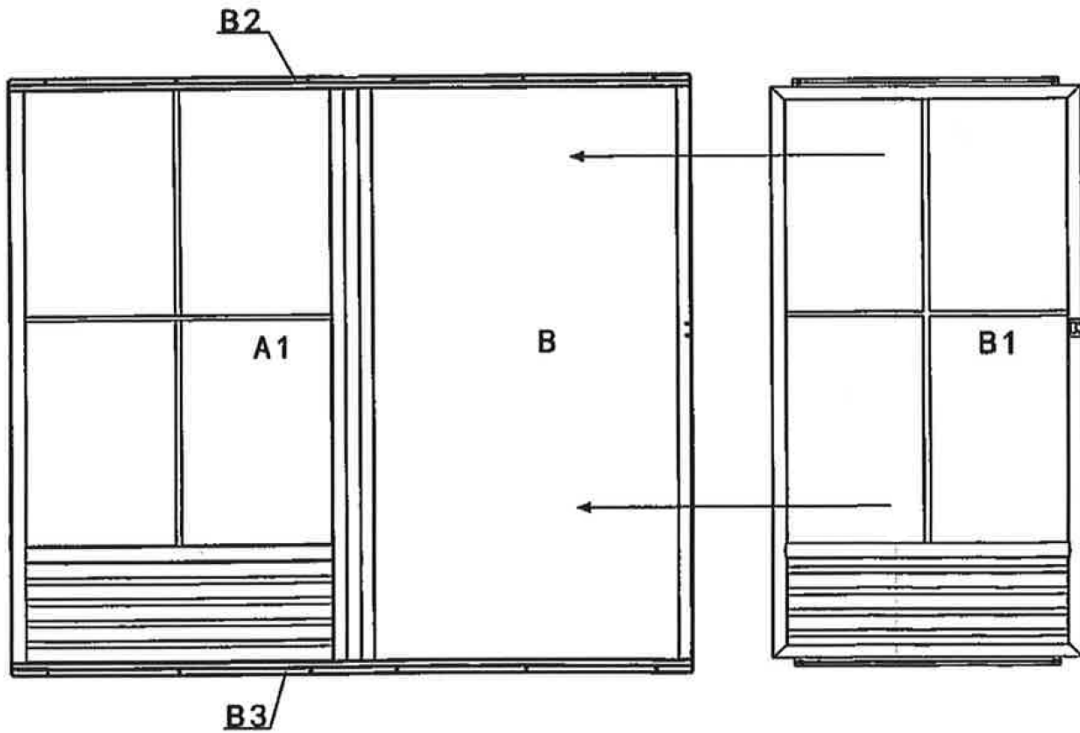
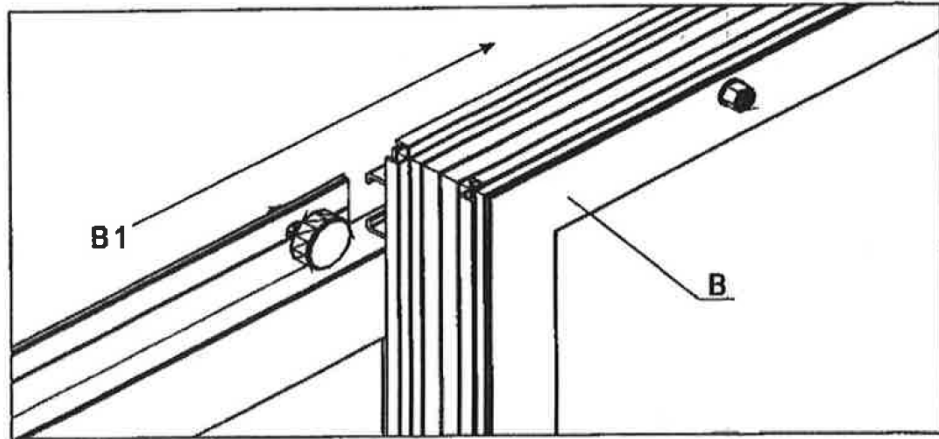

ASSEMBLAGE / ASSEMBLY

Étape 4 / Step 4

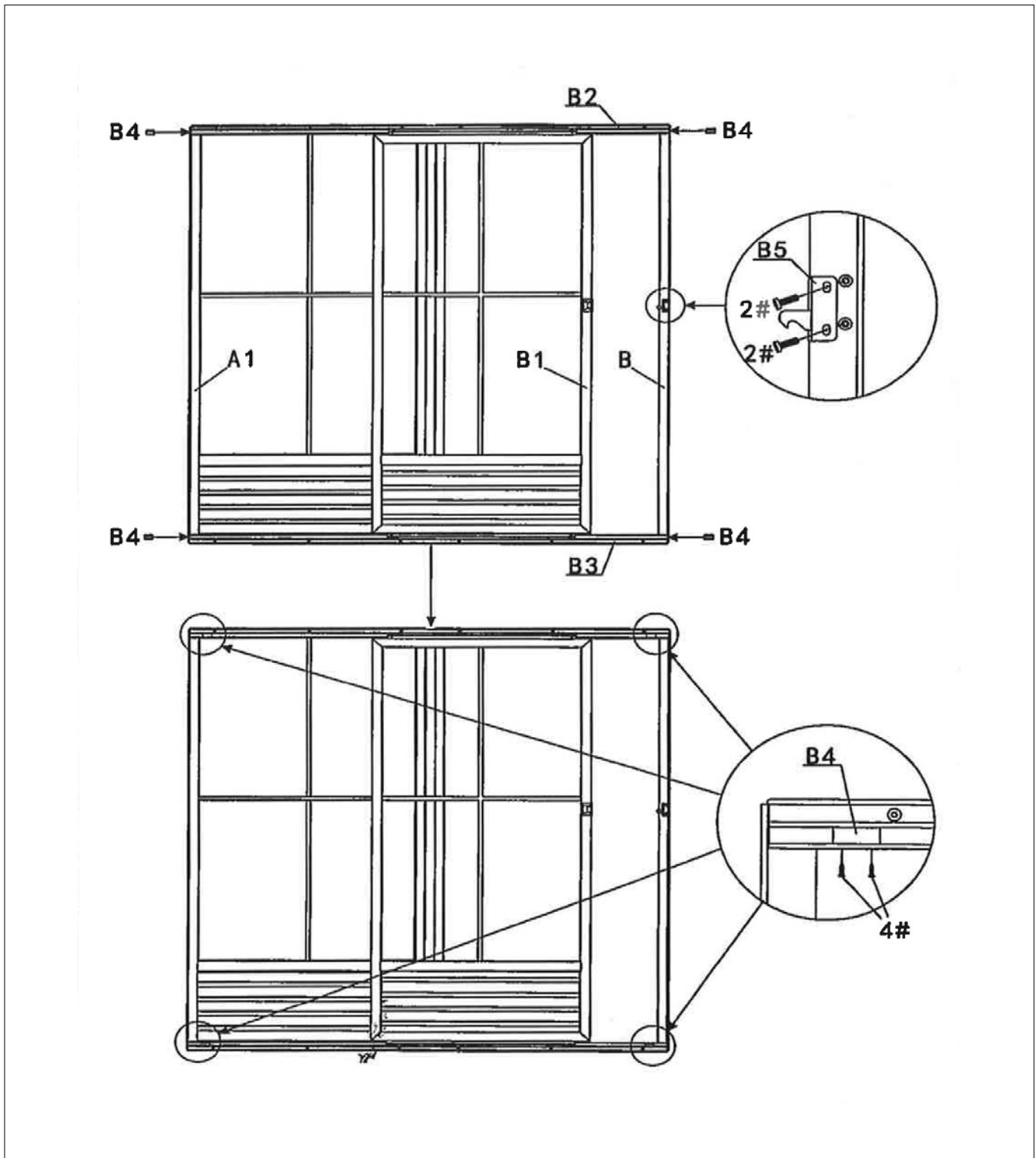

ASSEMBLAGE / ASSEMBLY

Étape 5 / Step 5

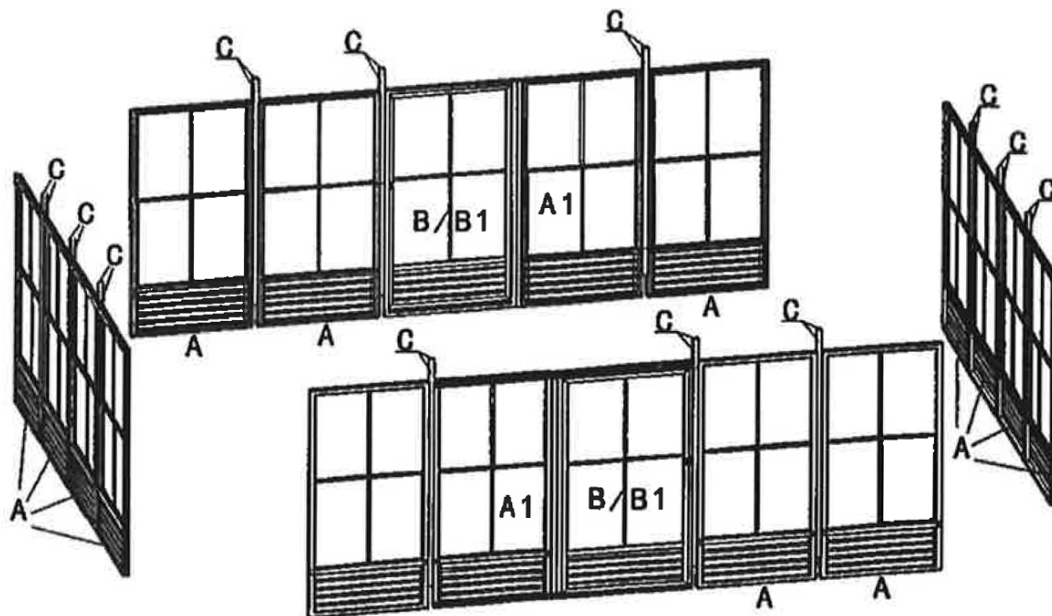
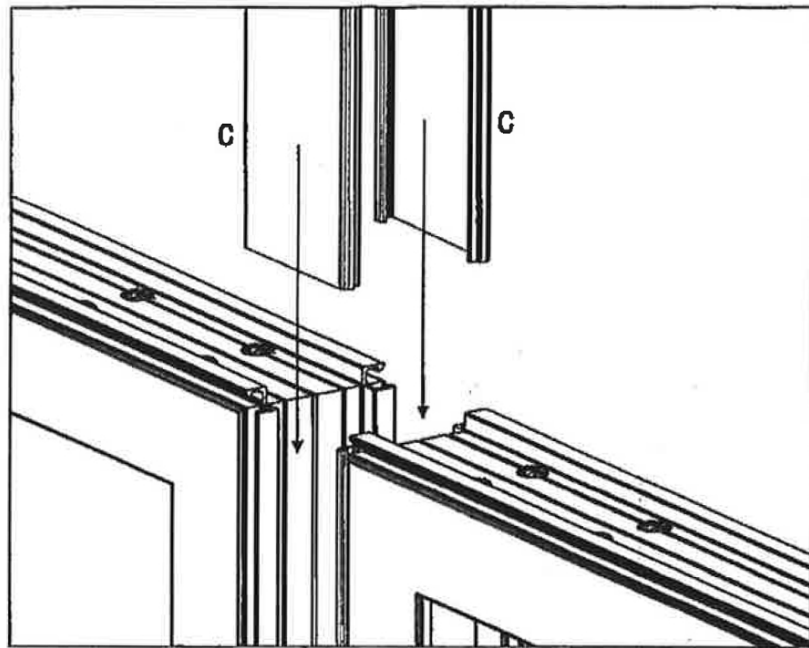

ASSEMBLAGE / ASSEMBLY

Étape 6 / Step 6

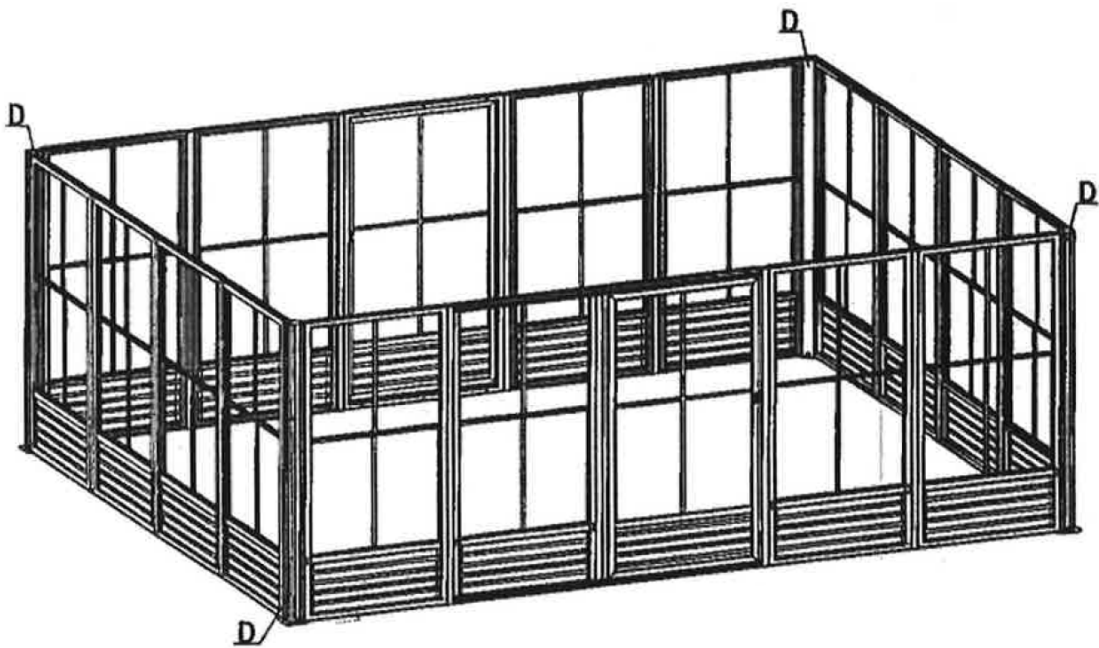
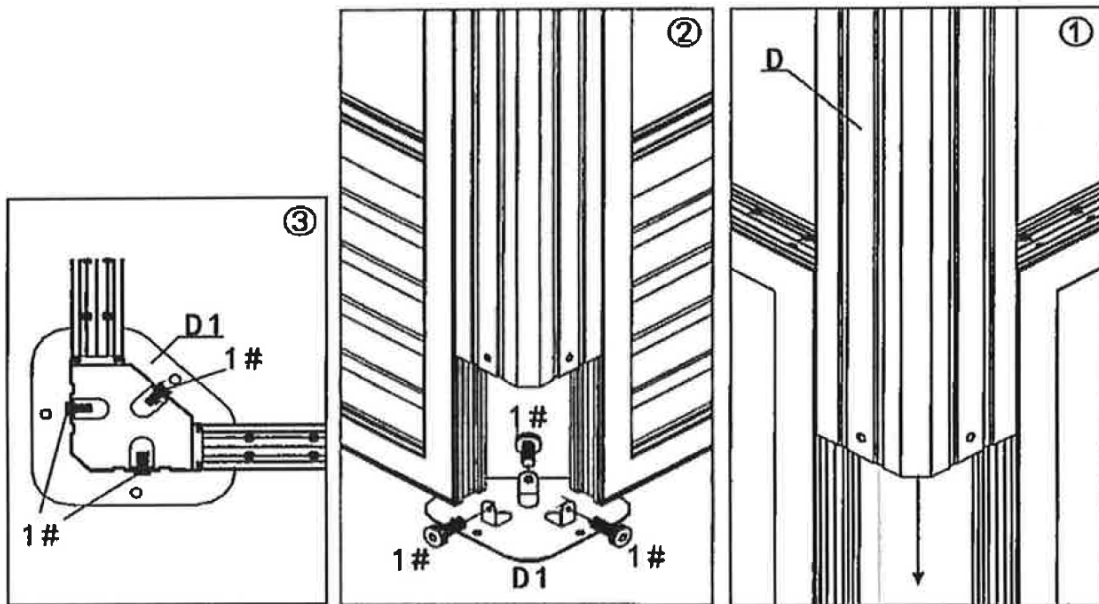

ASSEMBLAGE / ASSEMBLY

Étape 7 / Step 7

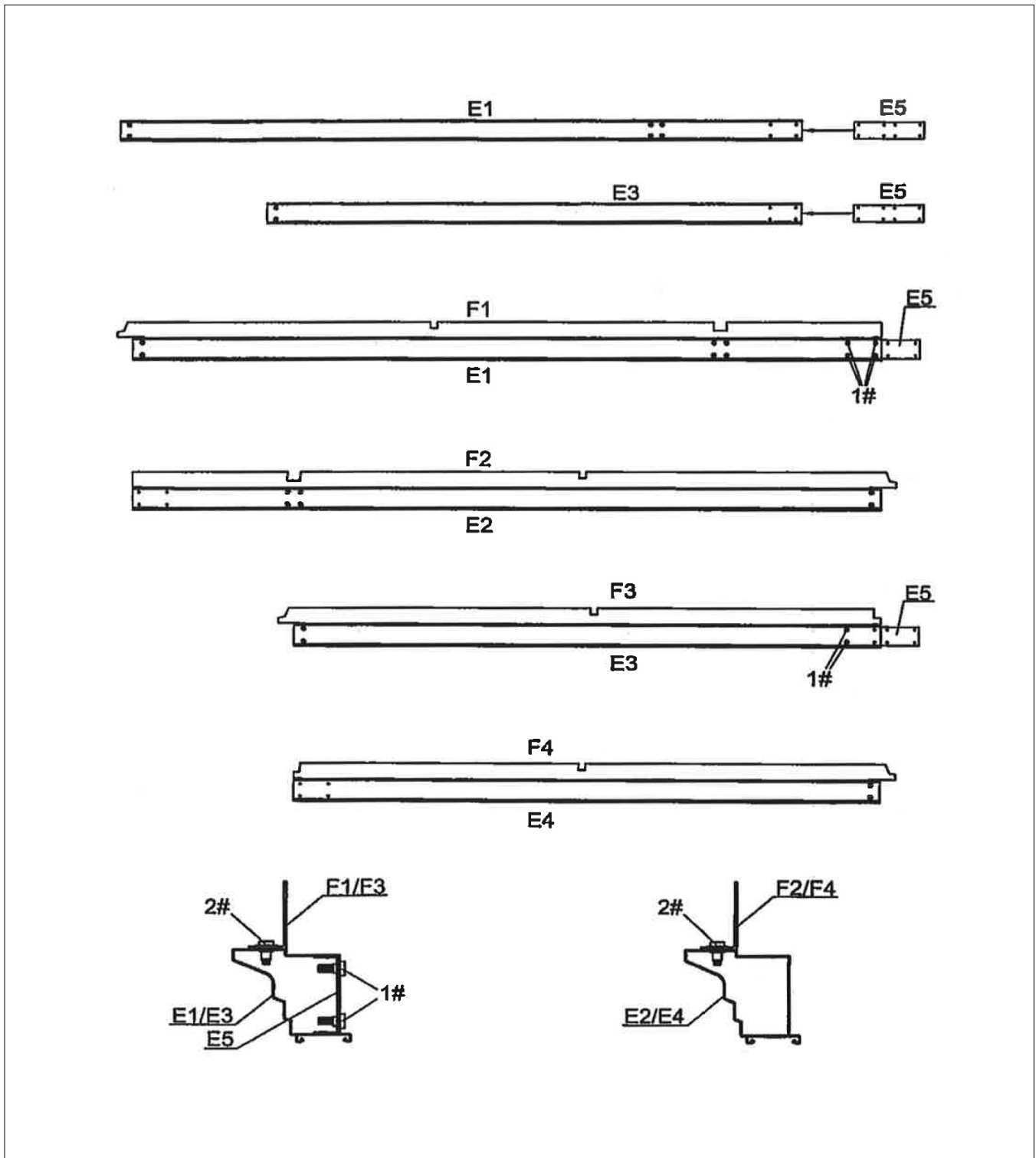

ASSEMBLAGE / ASSEMBLY

Étape 8 / Step 8

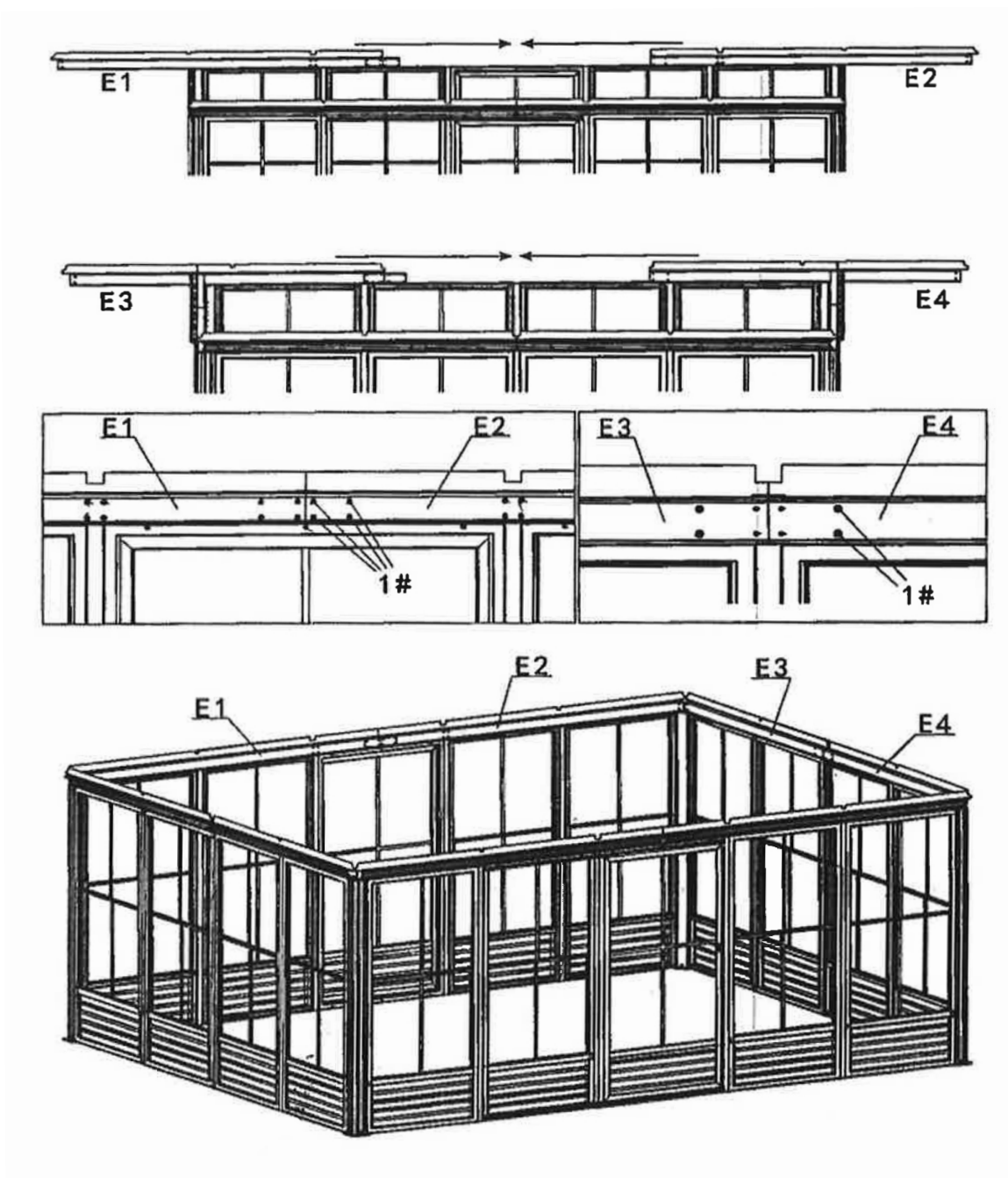

ASSEMBLAGE / ASSEMBLY

Étape 9 / Step 9

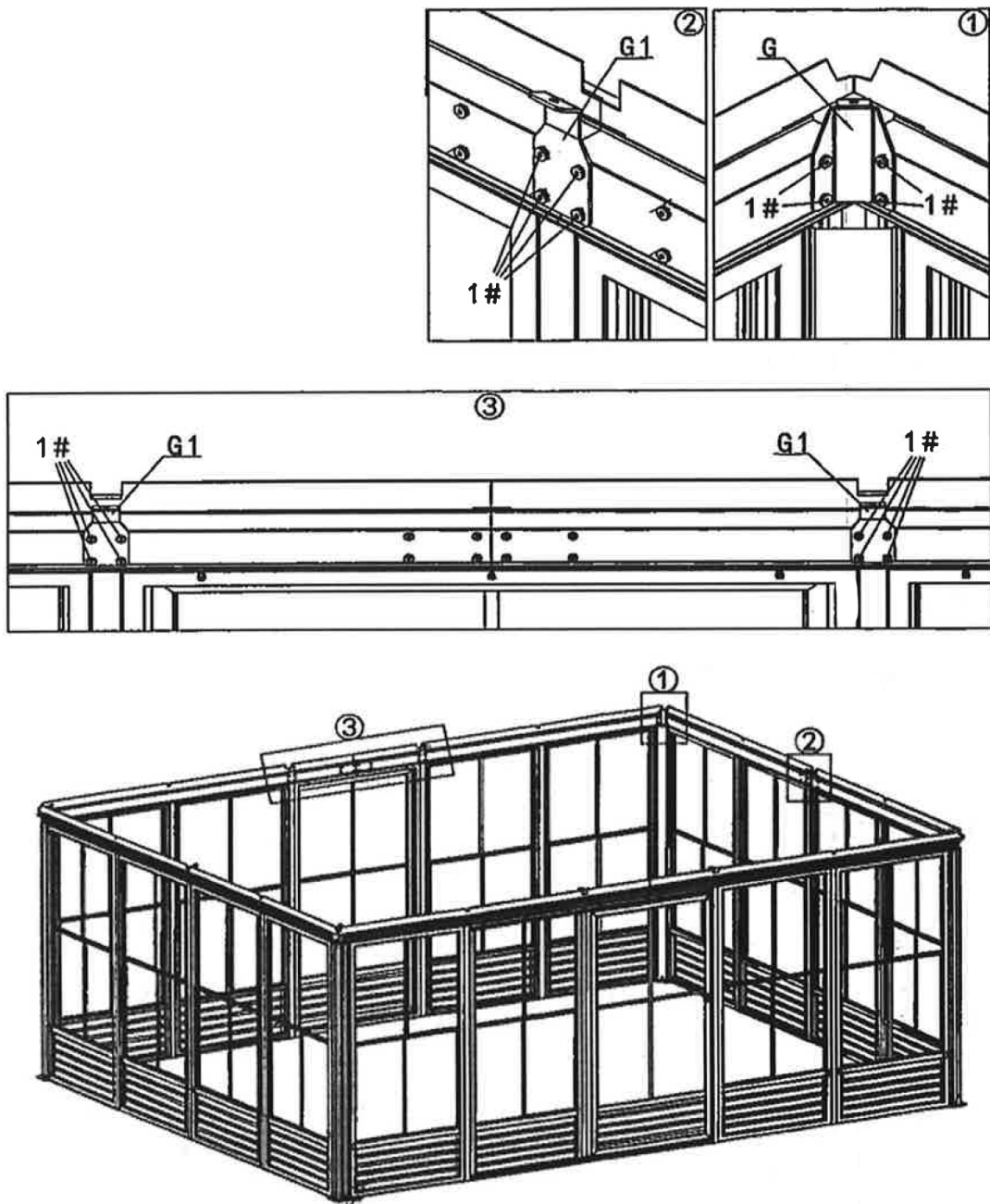

ASSEMBLAGE / ASSEMBLY

Étape 10 / Step 10

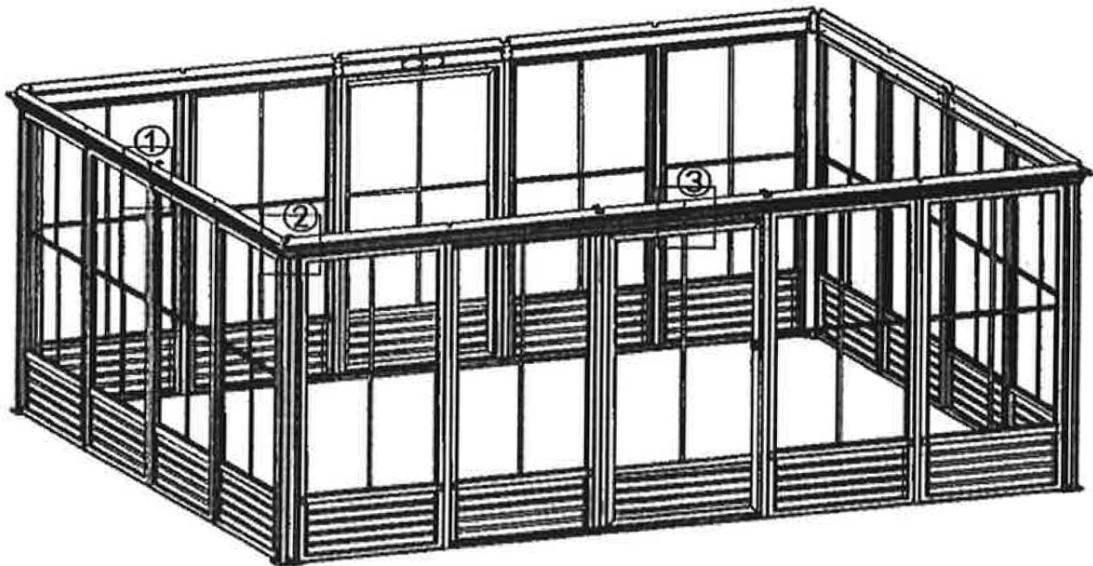
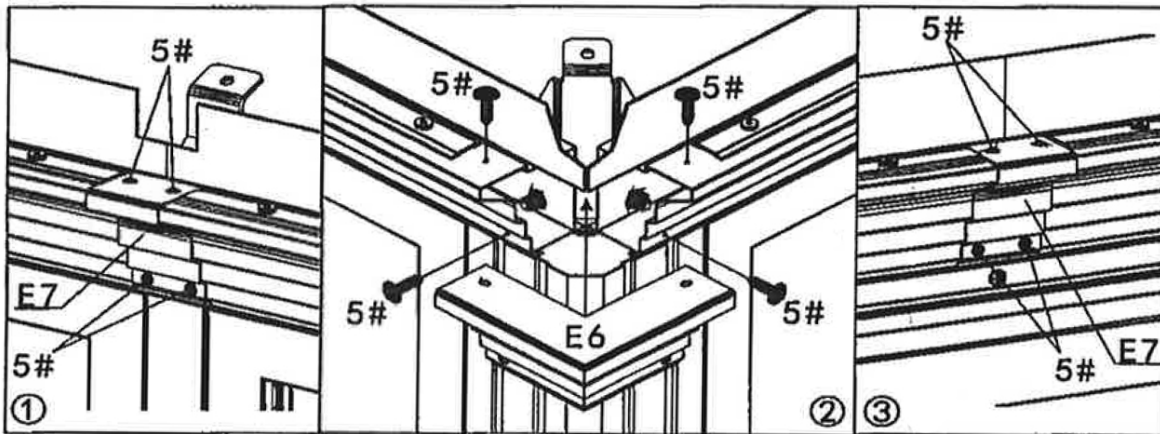

ASSEMBLAGE / ASSEMBLY

Étape 11 / Step 11

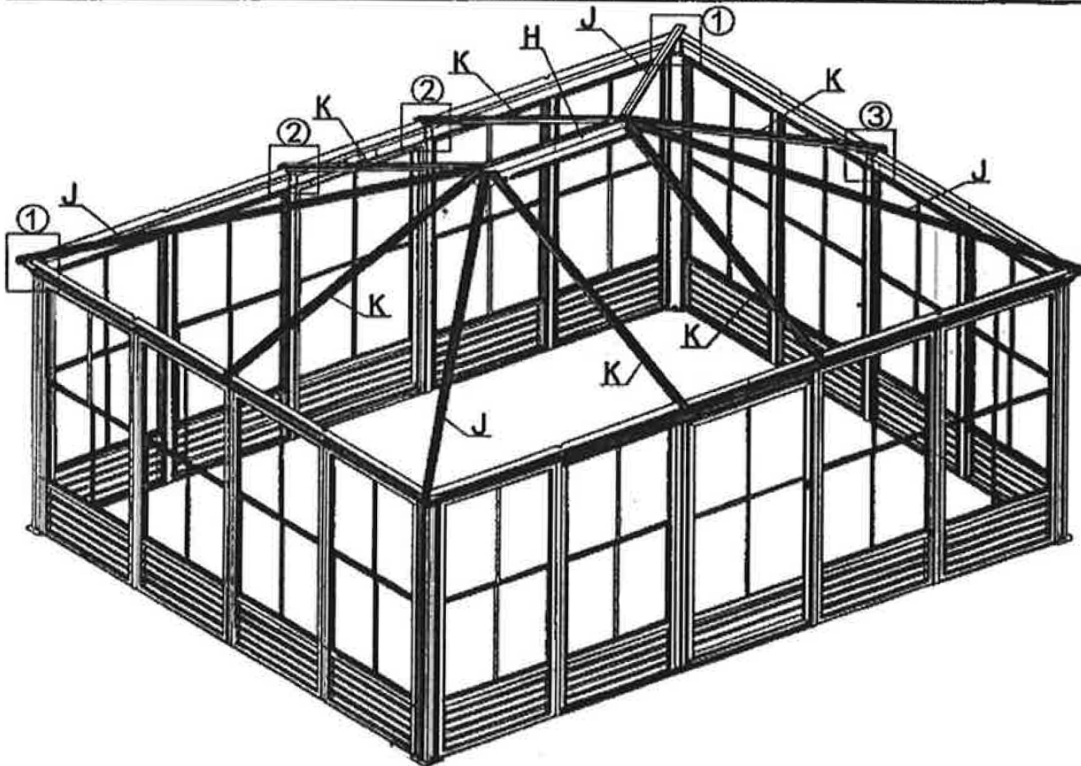
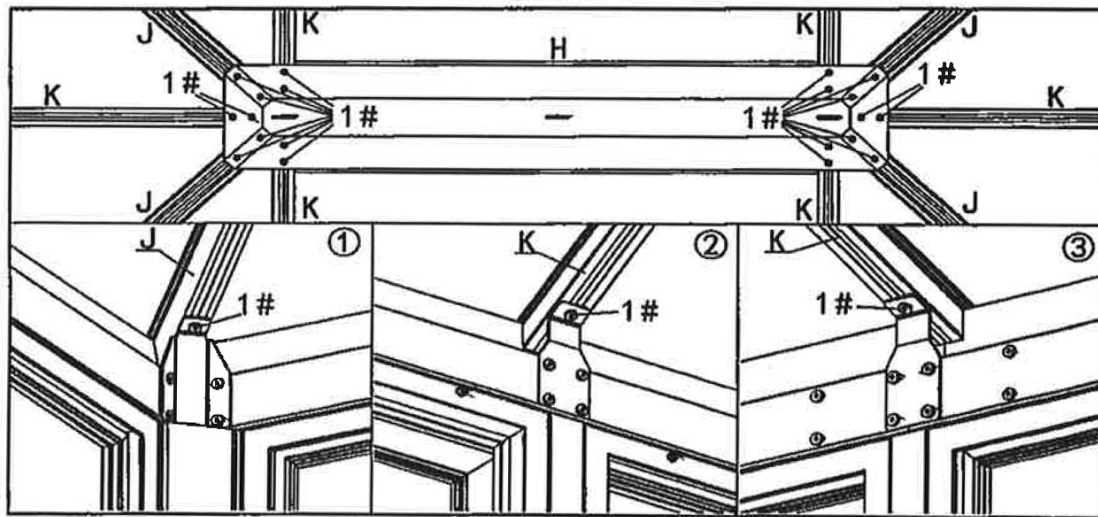

ASSEMBLAGE / ASSEMBLY

Étape 12 / Step 12

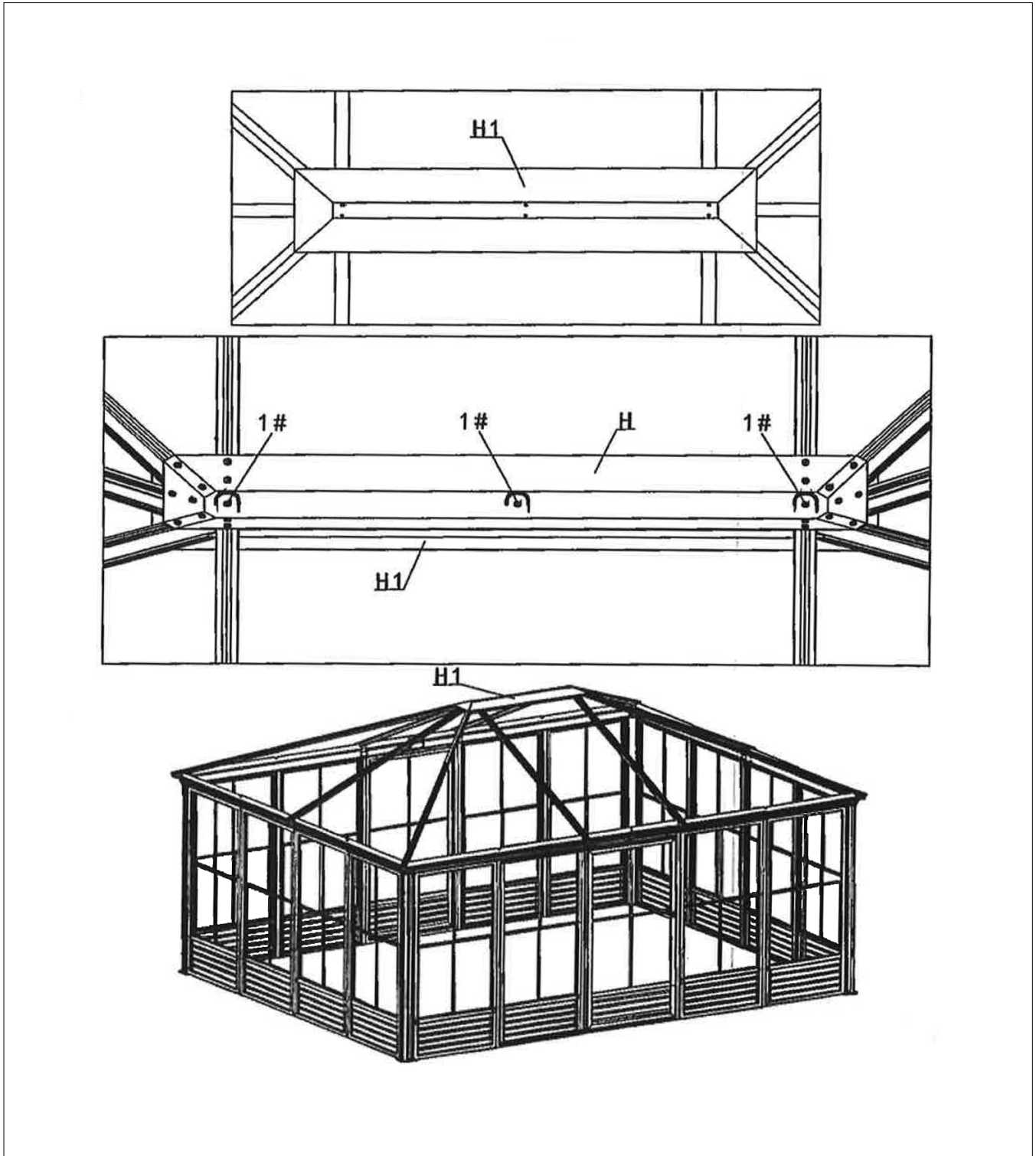

ASSEMBLAGE / ASSEMBLY

Étape 13 / Step 13

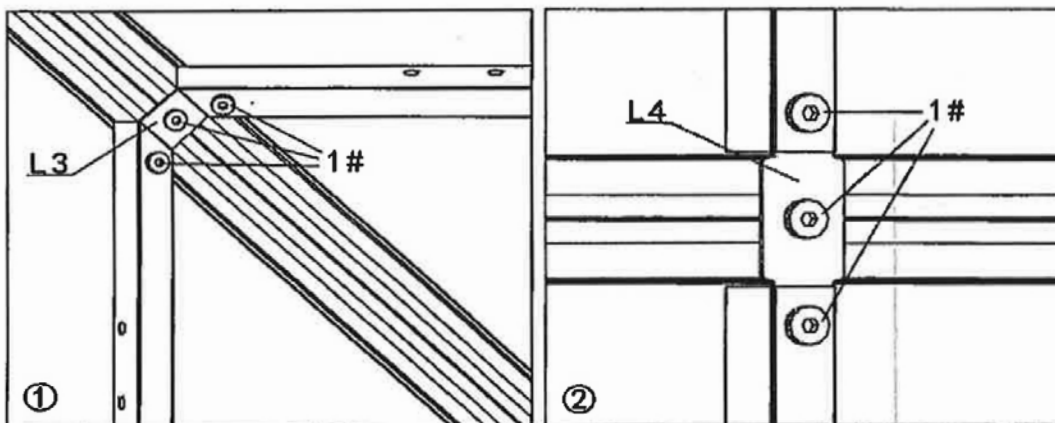
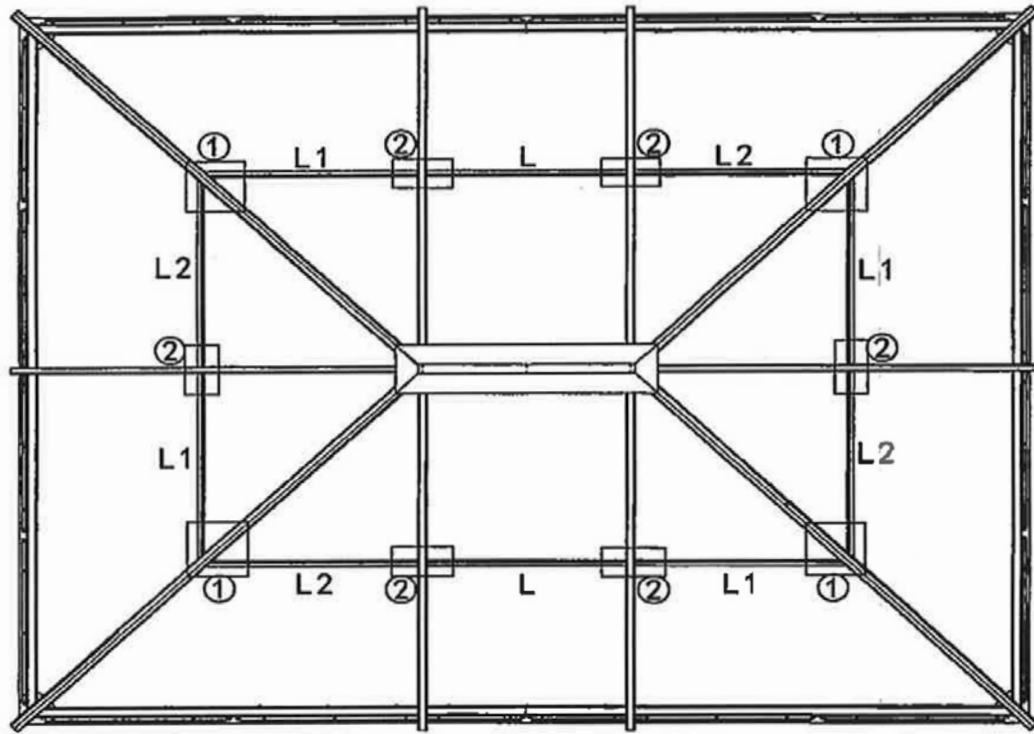

ASSEMBLAGE / ASSEMBLY

Étape 14 / Step 14

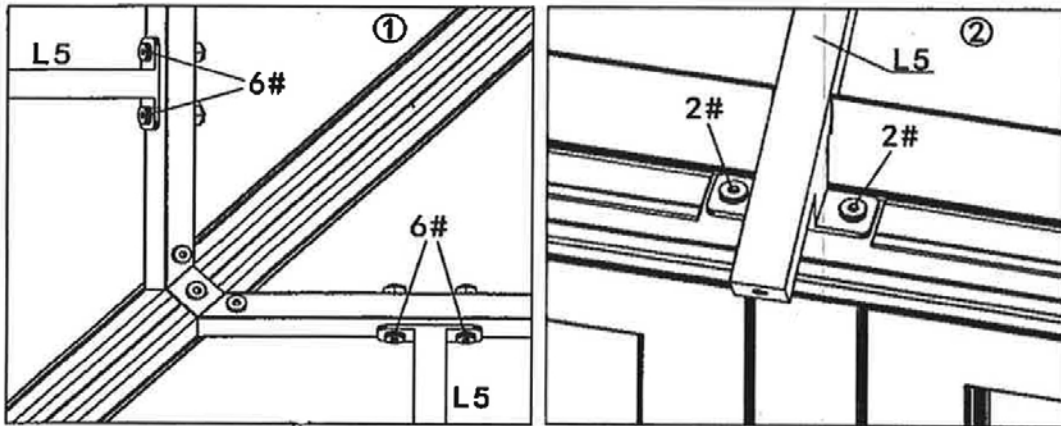
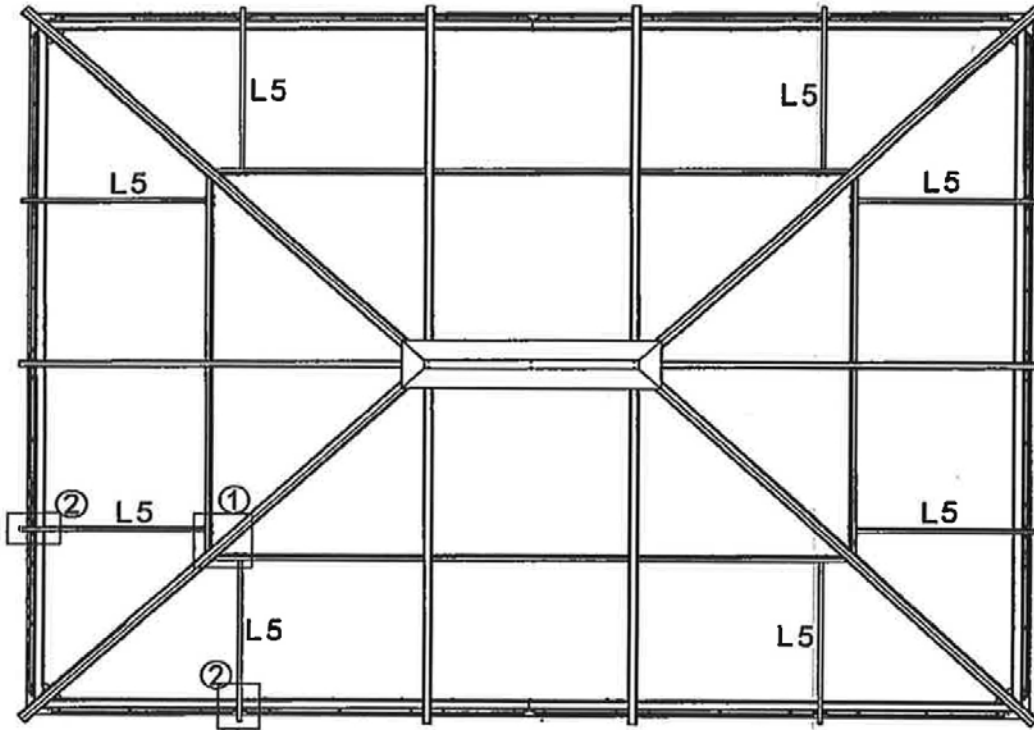

ASSEMBLAGE / ASSEMBLY

Étape 15 / Step 15

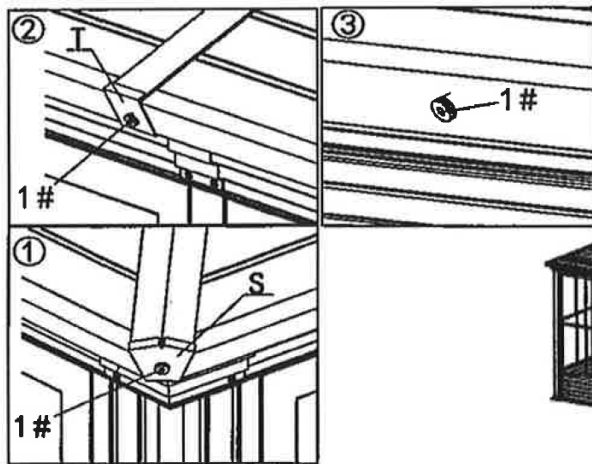
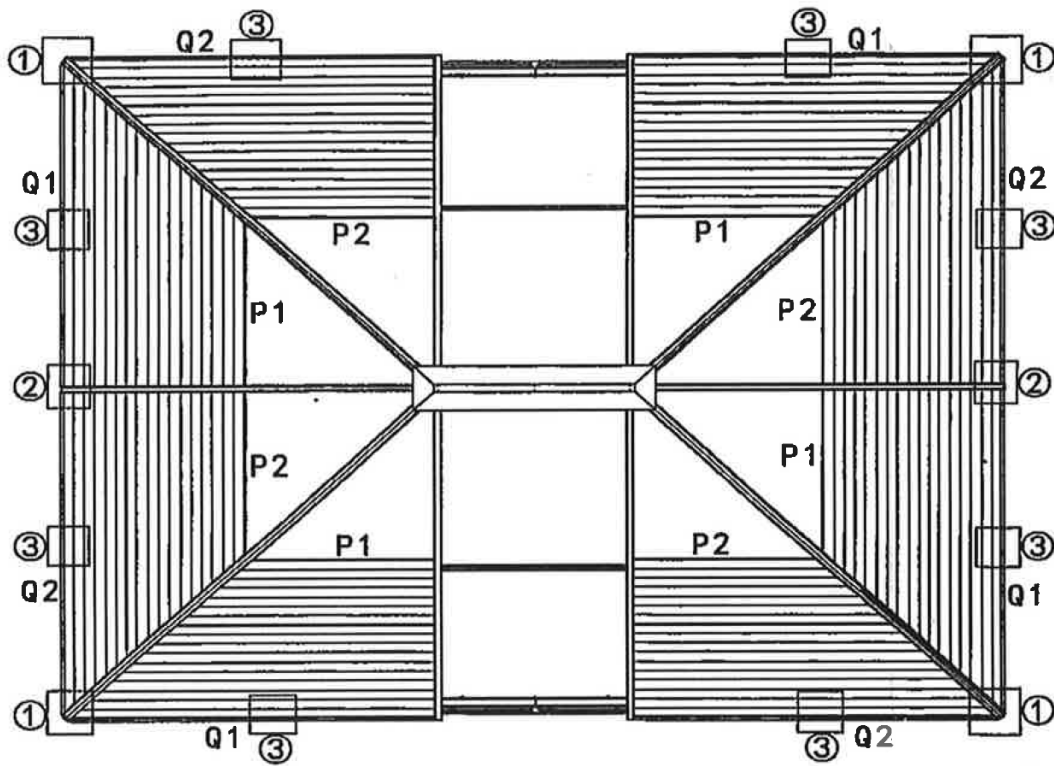

ASSEMBLAGE / ASSEMBLY

Étape 16 / Step 16

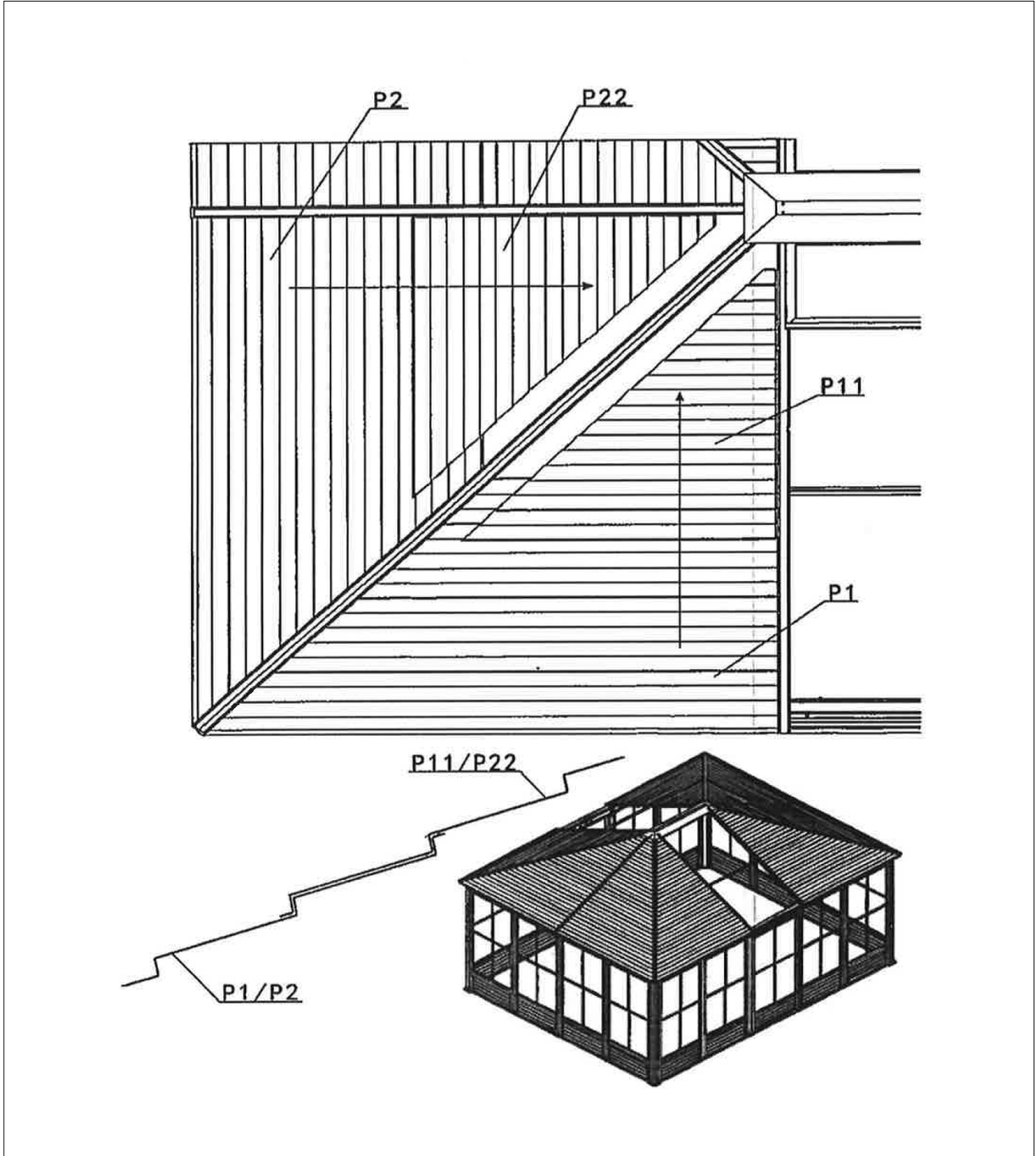

ASSEMBLAGE / ASSEMBLY

Étape 17 / Step 17

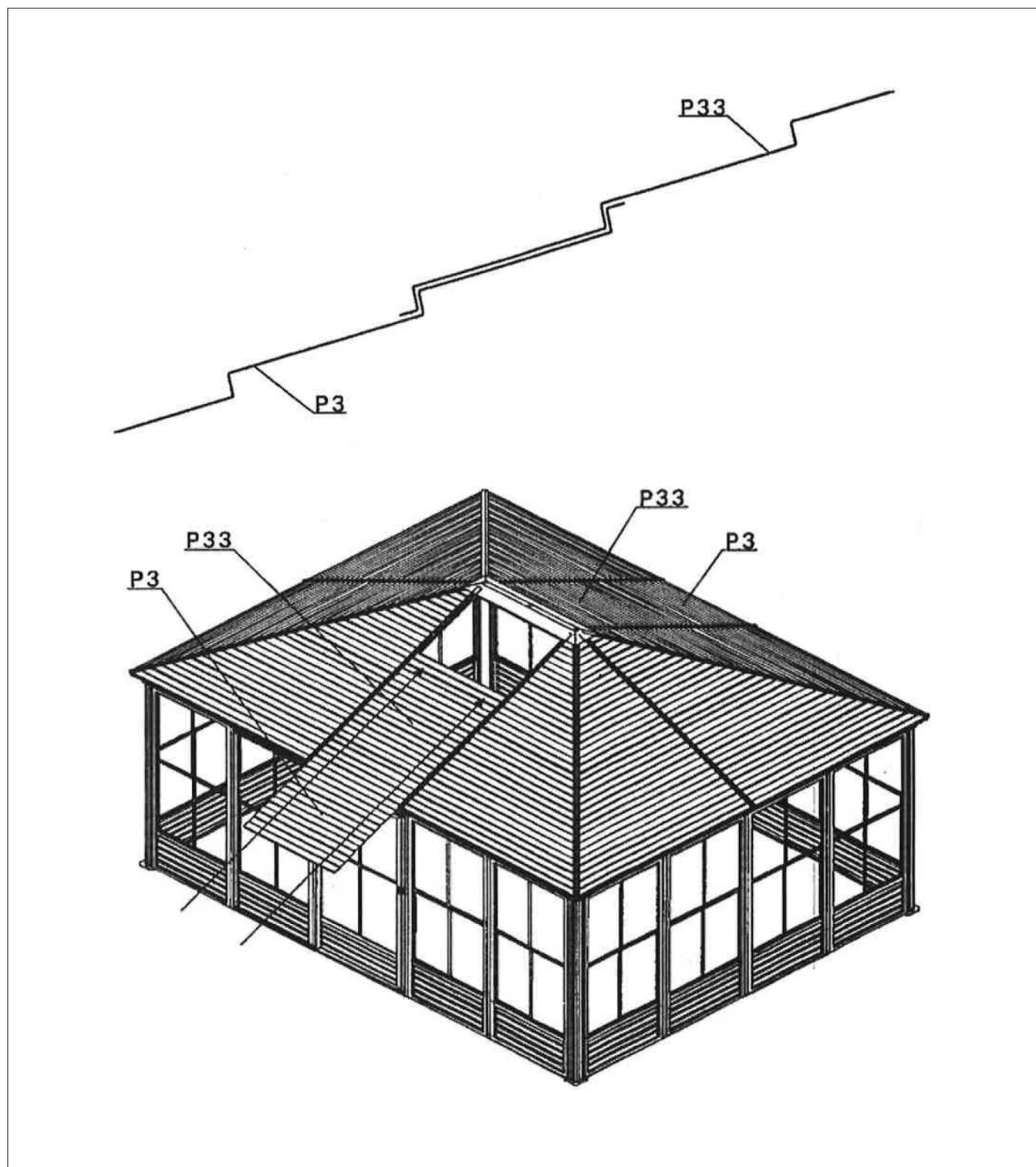

ASSEMBLAGE / ASSEMBLY

Étape 18 / Step 18

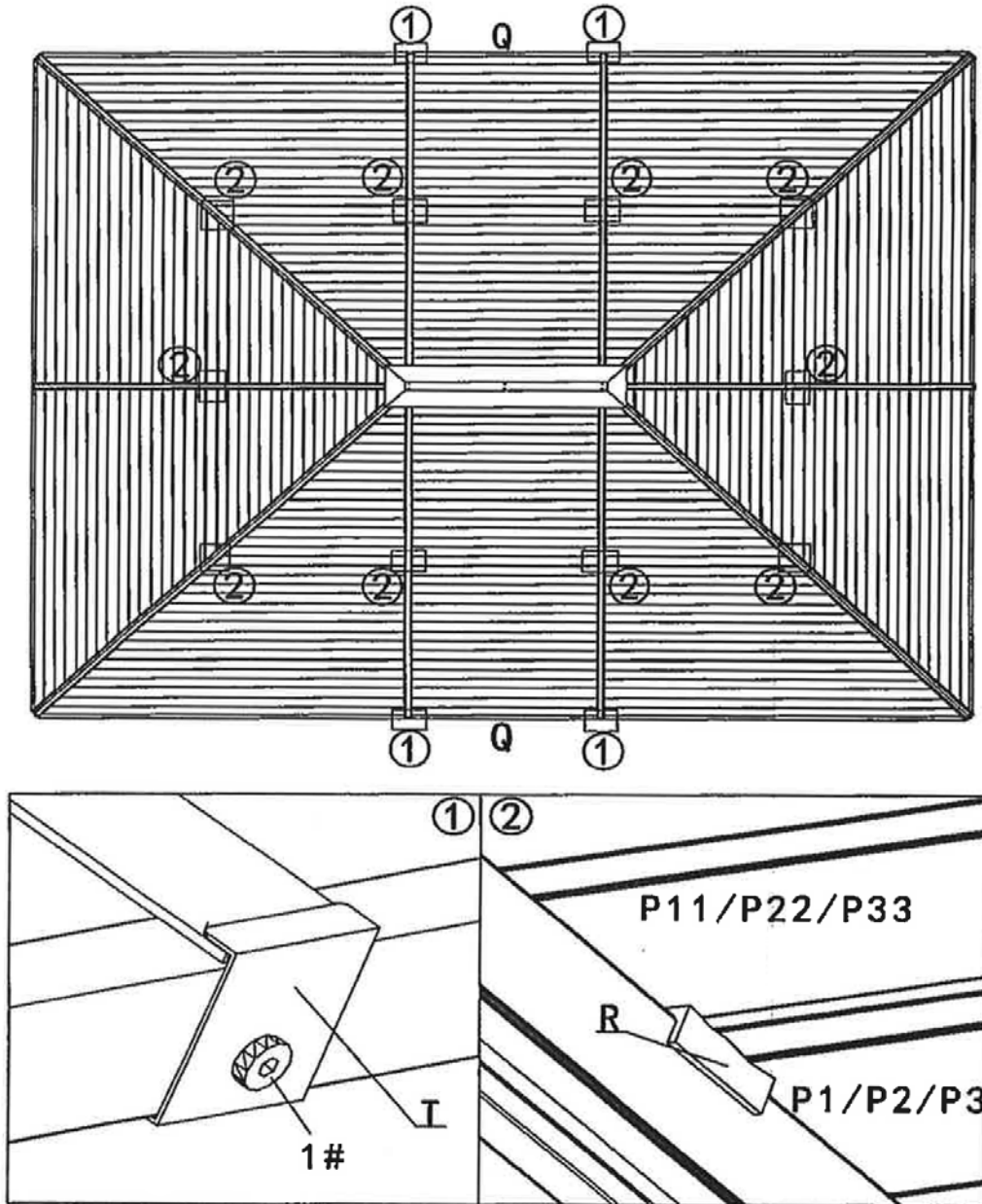

ASSEMBLAGE / ASSEMBLY

Étape 19 : Ancrage du pavillon / Step 19: Anchoring the pavilion

Le pavillon doit être ancré à un plancher de bois ou de béton en utilisant les vis appropriées à chaque type de plancher. Les clous de camping ne peuvent pas être utilisés comme ancrage permanent, sinon, la garantie sera alors annulée.

The pavilion must be anchored to either wood, stone tiles, or concrete using appropriate anchors to the type of floor on which it will be installed. Camp nails cannot be used for permanent anchoring. Failure to do so will nullify the warranty.

