

# PAVILLON PORT ROYAL 12' X 14'

12' x 14' Port Royal Pavilion

Référence / Reference : 27422

---

## GUIDE D'ASSEMBLAGE

Assembly Instructions

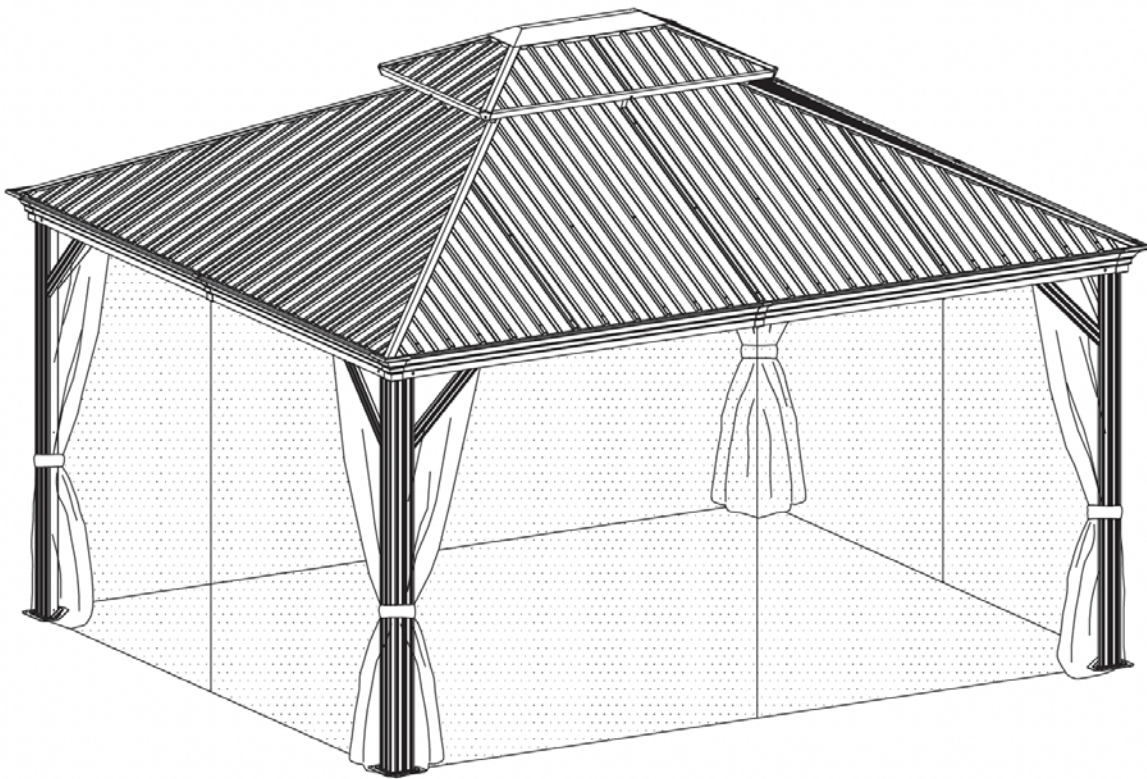











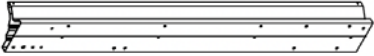
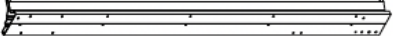
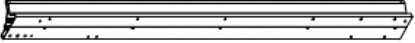







POUR TOUTE ASSISTANCE,  
CONTACTEZ VOTRE DÉTAILLANT.

For assistance, contact your retailer.













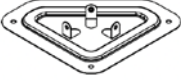
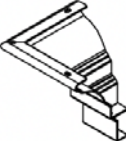

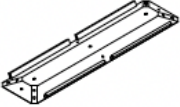
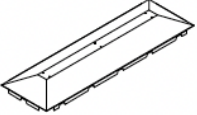
# PRÉASSEMBLAGE / PRE-ASSEMBLY

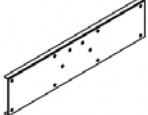
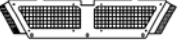
## Liste des pièces (1) / Parts List (1)

<b>A</b>		<b>x 4</b>	<b>B</b>		<b>x 2</b>
<b>B1</b>		<b>x 2</b>	<b>B2</b>		<b>x 2</b>
<b>B3</b>		<b>x 2</b>	<b>C</b>		<b>x 2</b>
<b>C1</b>		<b>x 2</b>	<b>C2</b>		<b>x 2</b>
<b>C3</b>		<b>x 2</b>	<b>D</b>		<b>x 2</b>
<b>D1</b>		<b>x 2</b>	<b>D2</b>		<b>x 2</b>
<b>D3</b>		<b>x 2</b>	<b>E</b>		<b>x 4</b>
<b>E1</b>		<b>x 4</b>	<b>F1</b>		<b>x 4</b>
<b>F2</b>		<b>x 4</b>	<b>G1</b>		<b>x 2</b>
<b>G2</b>		<b>x 2</b>	<b>G3</b>		<b>x 2</b>
<b>G4</b>		<b>x 2</b>			

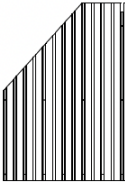
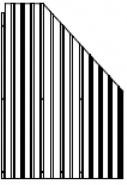

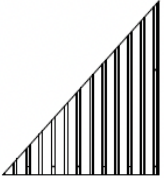
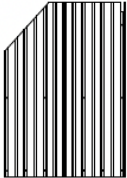
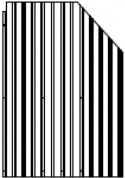
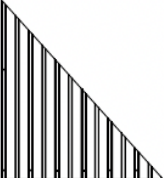
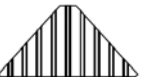
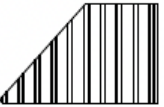

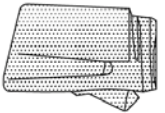





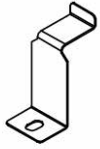
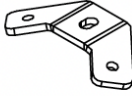
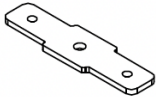
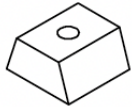
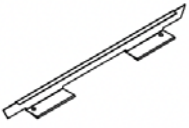
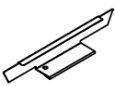

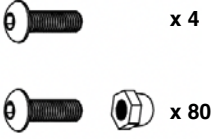
# PRÉASSEMBLAGE / PRE-ASSEMBLY

Liste des pièces (2) / Parts List (2)

<b>H</b>	<b>x 4</b>	<b>H1</b>	<b>x 4</b>	<b>J</b>	<b>x 4</b>	<b>K</b>	<b>x 4</b>	<b>K1</b>	<b>x 4</b>
									
<b>L</b>	<b>x 1</b>	<b>M</b>	<b>x 1</b>	<b>N</b>	<b>x 8</b>	<b>P</b>	<b>x 4</b>	<b>U1</b>	<b>x 2</b>
									
<b>U2</b>	<b>x 2</b>	<b>U3</b>	<b>x 2</b>	<b>Q1</b>	<b>x 2</b>	<b>Q2</b>	<b>x 2</b>	<b>Q3</b>	<b>x 2</b>
									
<b>Q4</b>	<b>x 2</b>	<b>R1</b>	<b>x 2</b>	<b>R2</b>	<b>x 2</b>	<b>R3</b>	<b>x 2</b>	<b>R4</b>	<b>x 2</b>
									
<b>S</b>	<b>x 2</b>	<b>S1</b>	<b>x 2</b>	<b>S2</b>	<b>x 2</b>	<b>T</b>	<b>x 4</b>	<b>T1</b>	<b>x 4</b>
									

# PRÉASSEMBLAGE / PRE-ASSEMBLY

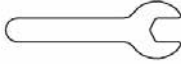
## Liste des pièces (3) / Parts List (3)

<b>U</b>	<b>x 120</b>	<b>V</b>	<b>x 4</b>	<b>W</b>	<b>x 4</b>	<b>W1</b>	<b>x 4</b>	<b>Y</b>	<b>x 116</b>
									
<b>Z</b>	<b>x 72</b>	<b>Z1</b>	<b>x 12</b>	<b>#1</b>	<b>x 237</b>	<b>#2</b>	<b>x 4 + x 80</b>	<b>#3</b>	<b>x 4</b>
									
				M6x15		M6x23		M5x12	
<b>#4</b>	<b>x 24</b>	<b>#5</b>	<b>x 2</b>	<b>#6</b>	<b>x 8</b>	<b>#7</b>	<b>x 24</b>	<b>#8</b>	<b>x 8</b>
									
ST4.8x12				M6x42		M6x47			
<b>#10</b>	<b>x 8</b>	<b>x 1</b>	<b>x 1</b>	<b>x 1</b>	<b>x 12</b>				
									
M6x10									

# ASSEMBLAGE / ASSEMBLY

## Étape / Step 1

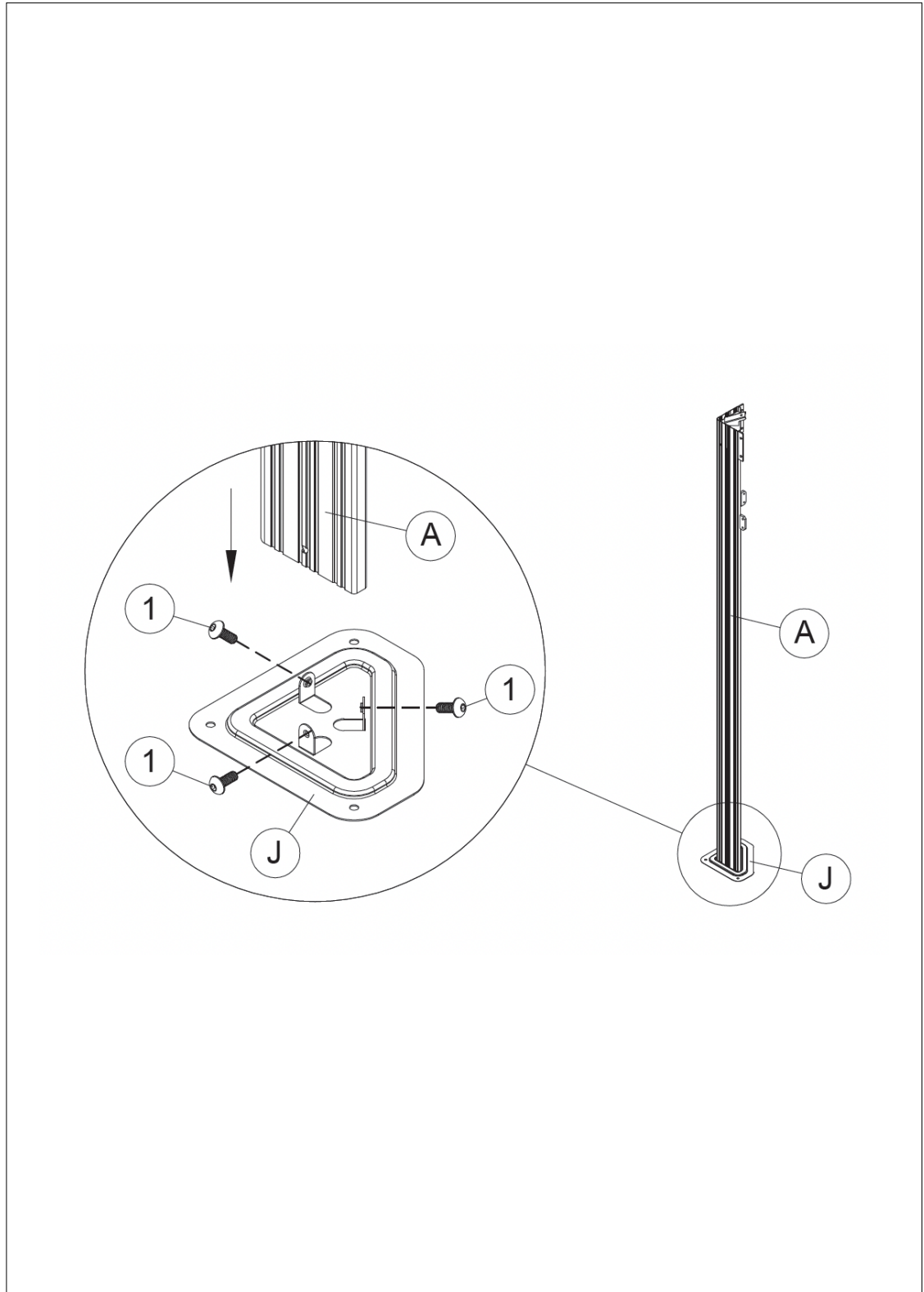
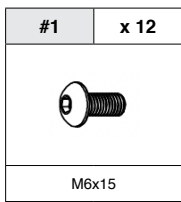
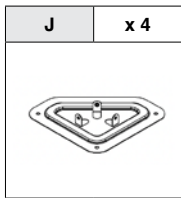
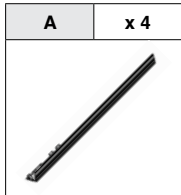

# ASSEMBLAGE / ASSEMBLY

Étape / Step 2

<b>B</b>	<b>x 2</b>
<b>B1</b>	<b>x 2</b>
<b>C</b>	<b>x 2</b>
<b>C1</b>	<b>x 2</b>
<b>D</b>	<b>x 2</b>
<b>D1</b>	<b>x 2</b>
<b>P</b>	<b>x 2</b>
<b>#1</b>	<b>x 52</b>
M6x15	

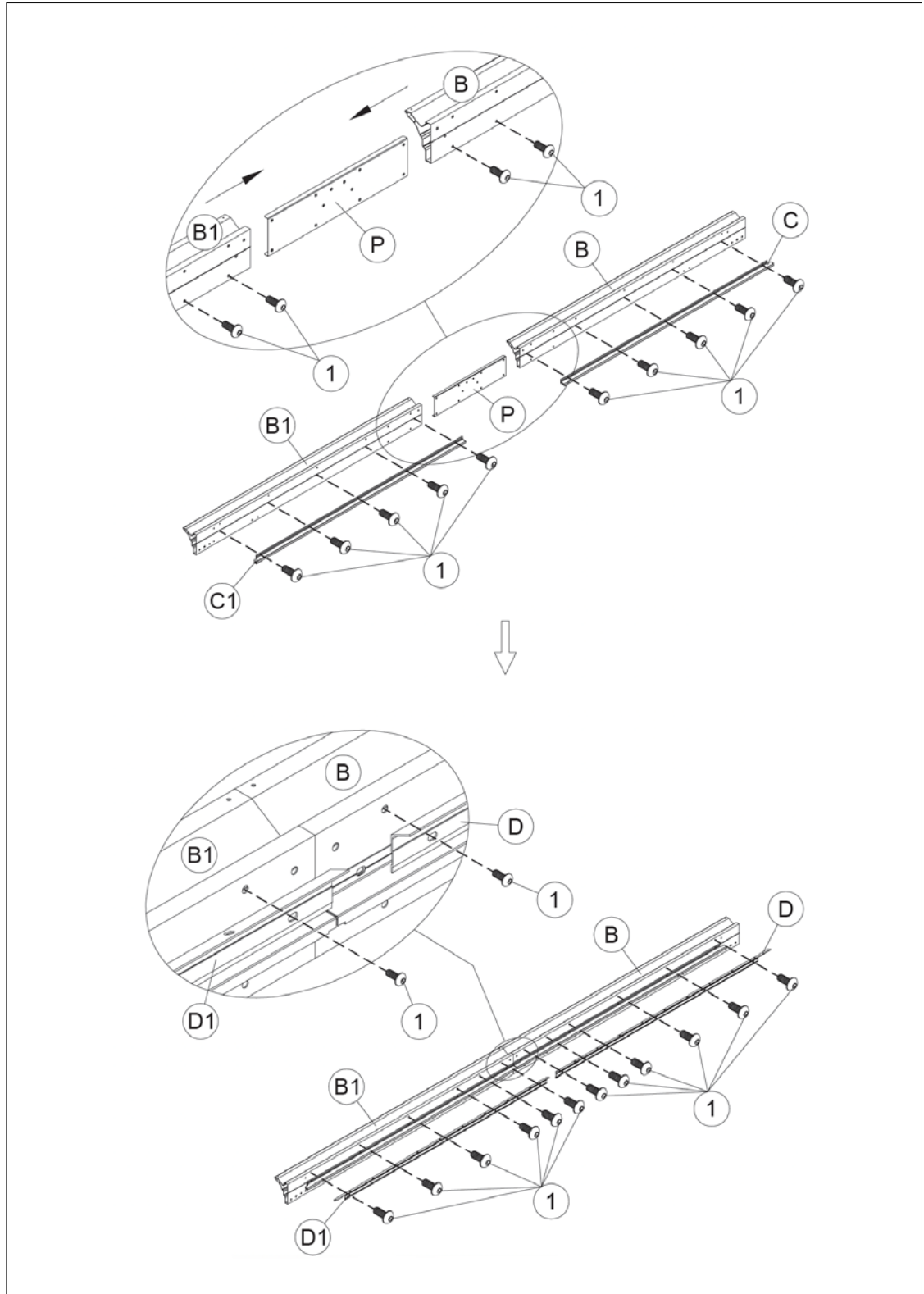



# ASSEMBLAGE / ASSEMBLY

## Étape / Step 3

B2	x 2
B3	x 2
C2	x 2
C3	x 2
D2	x 2
D3	x 2
P	x 2
#1	x 52
M6x15	

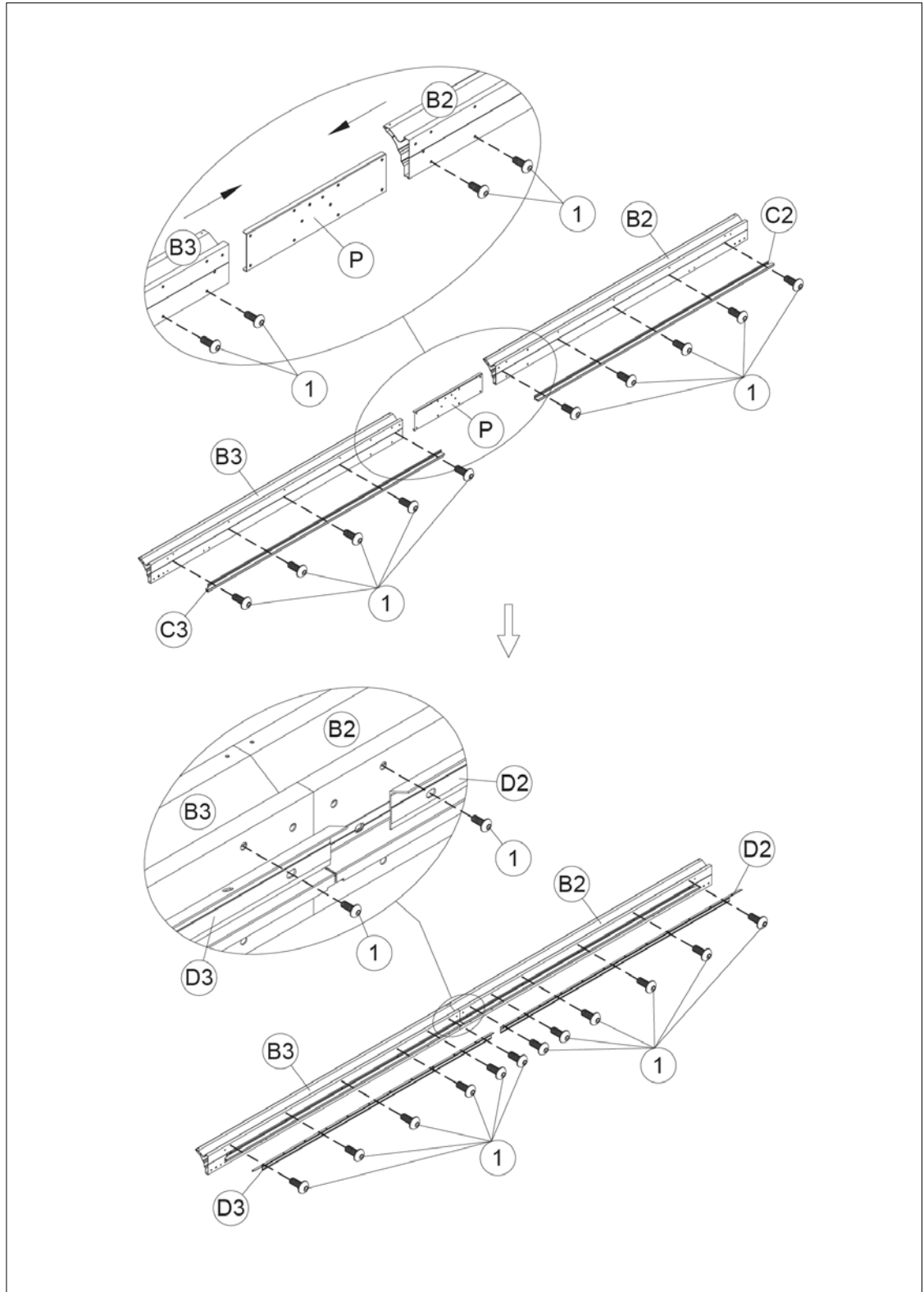

# ASSEMBLAGE / ASSEMBLY

Étape / Step 4

#1	x 24
	
M6x15	

#8	x 8
	

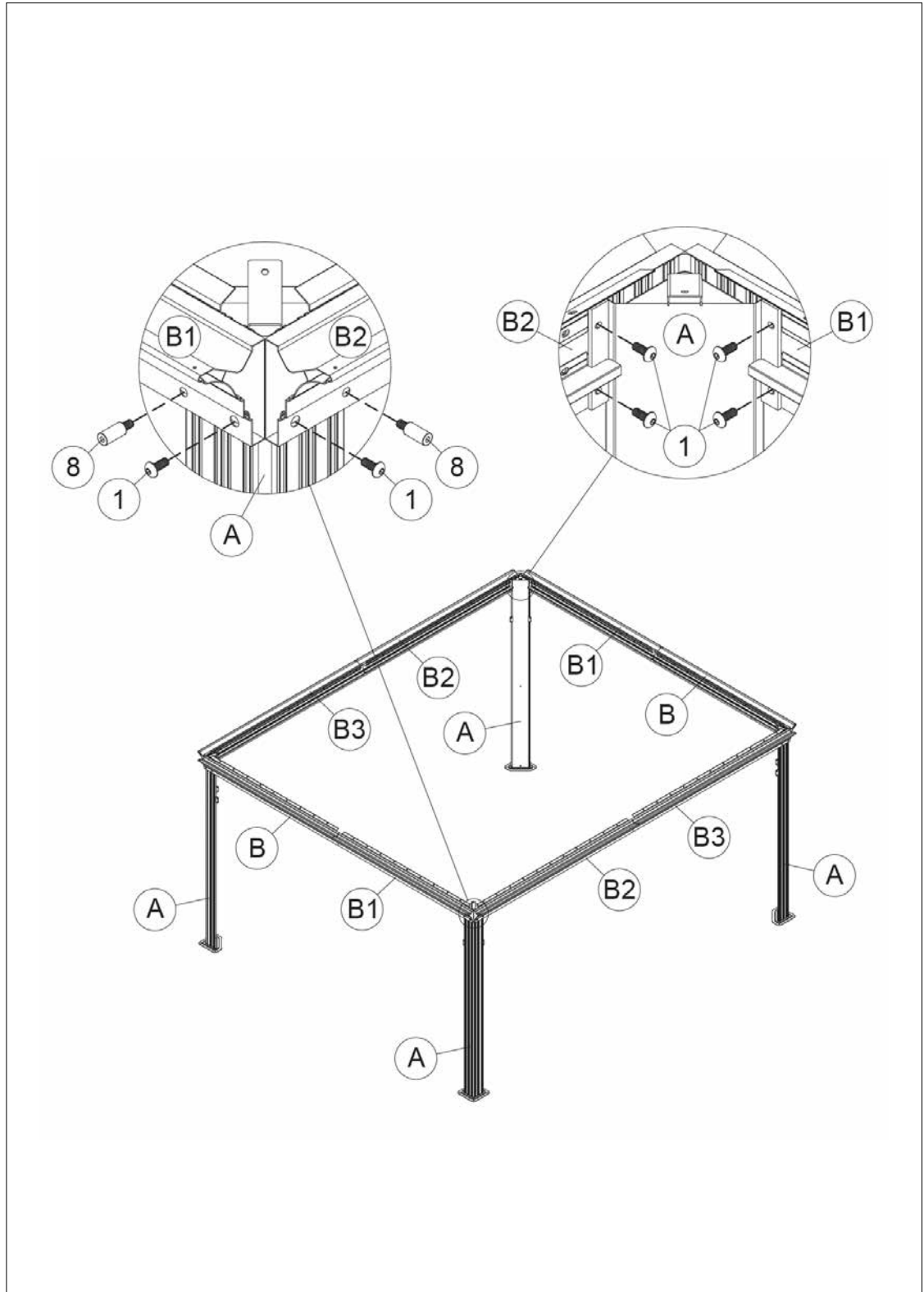



# ASSEMBLAGE / ASSEMBLY

Étape / Step 5

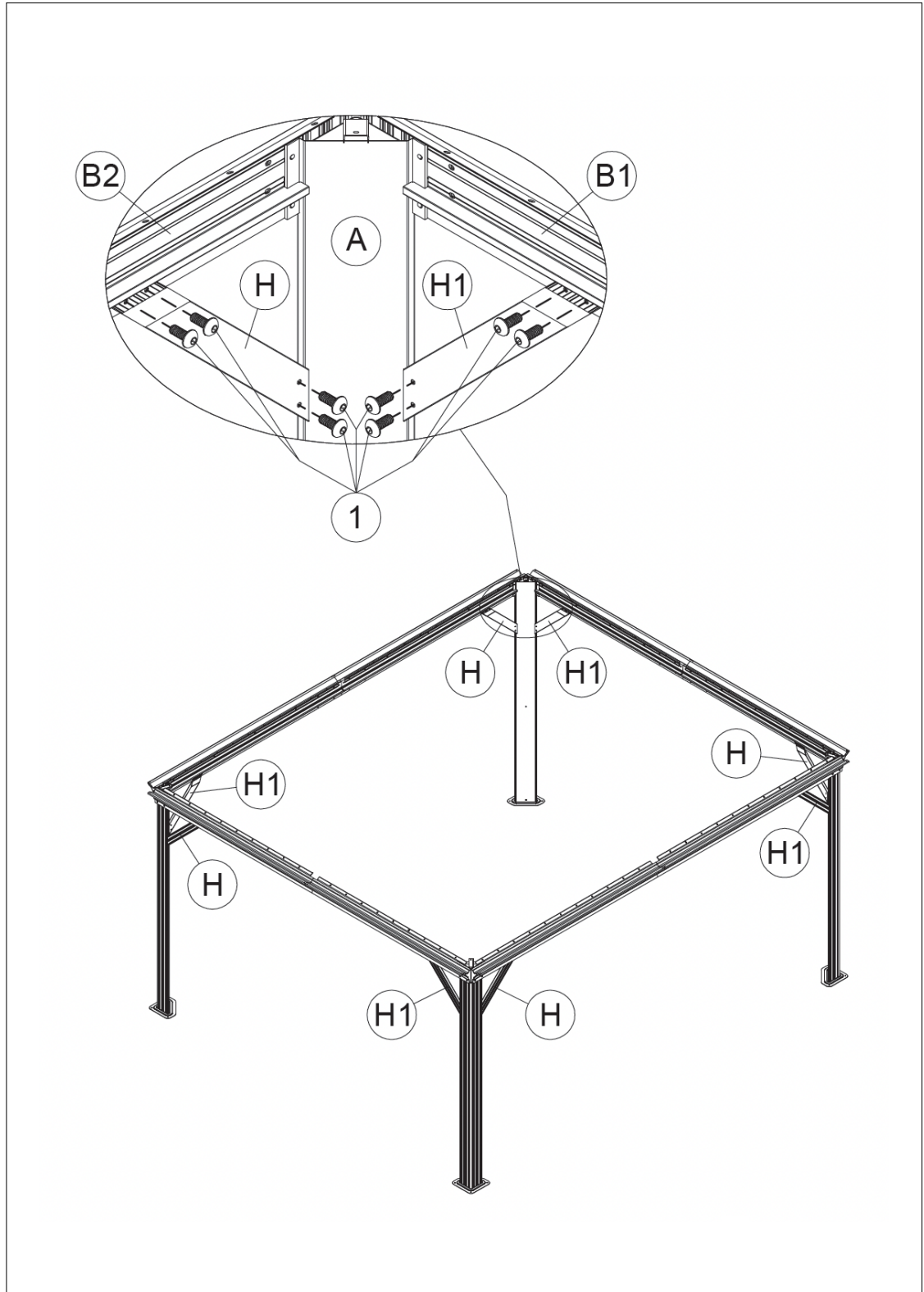
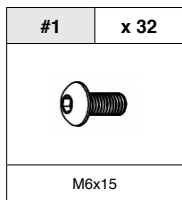
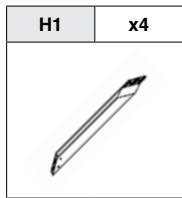
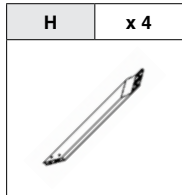

# ASSEMBLAGE / ASSEMBLY

## Étape / Step 6

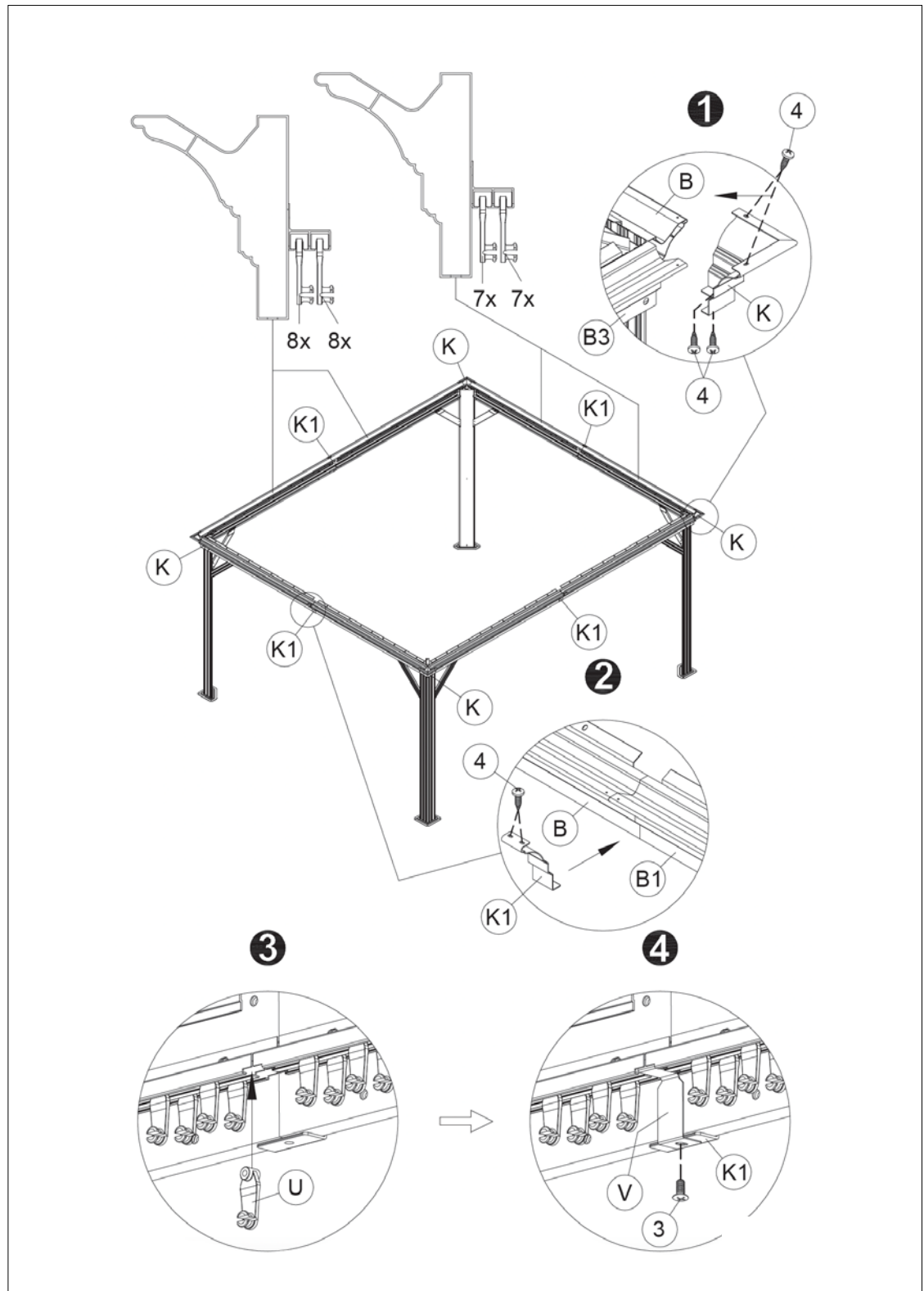
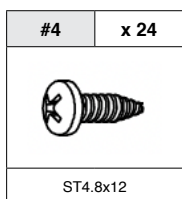
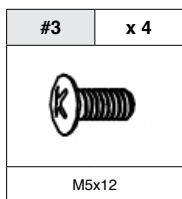
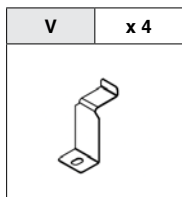
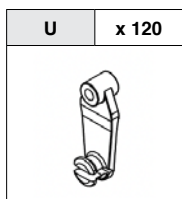
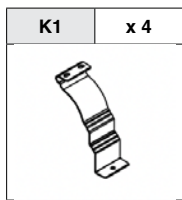
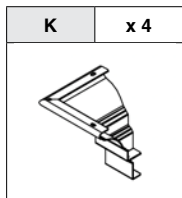

# ASSEMBLAGE / ASSEMBLY

## Étape / Step 7

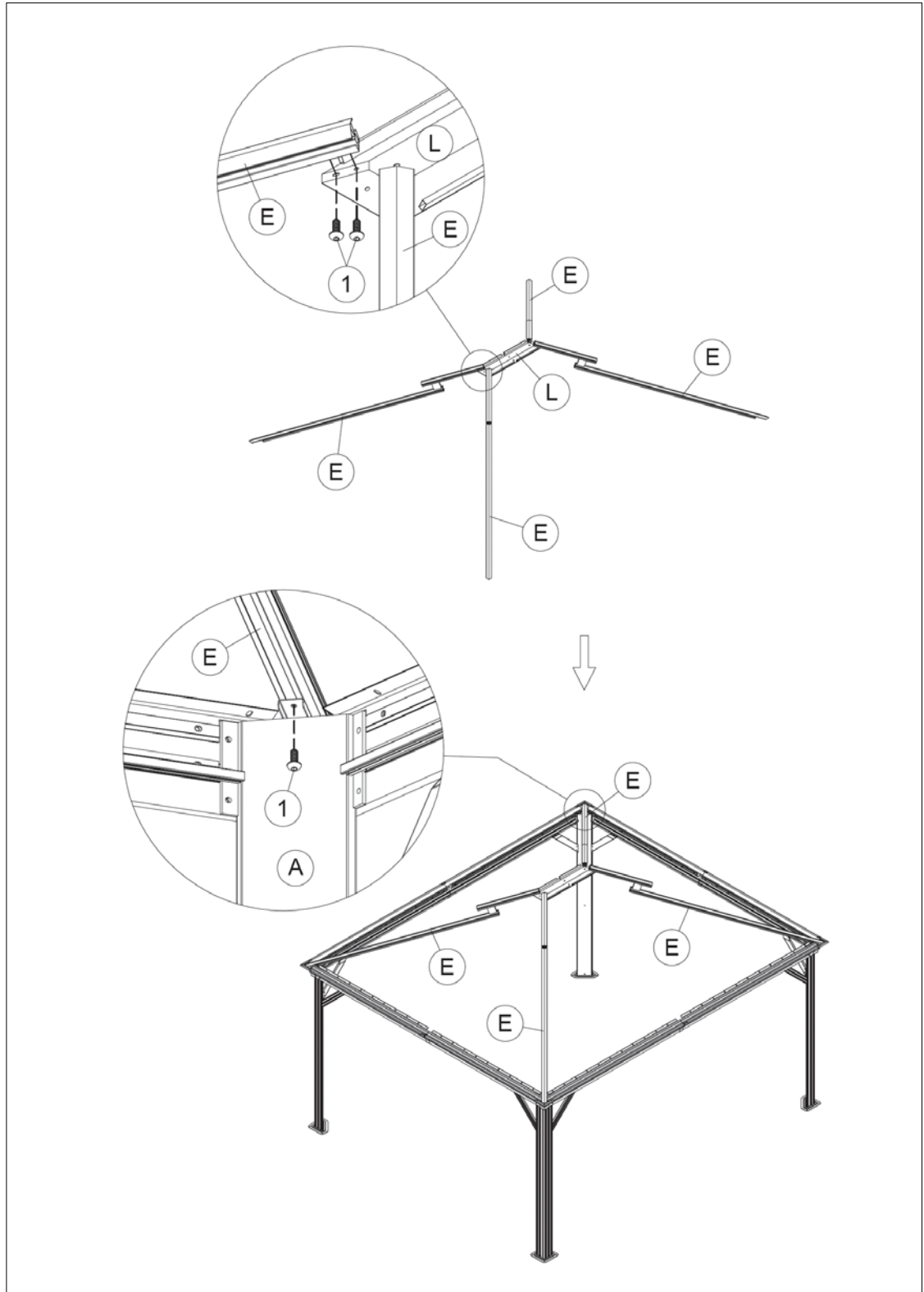
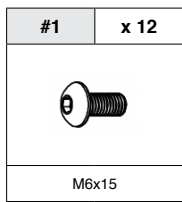
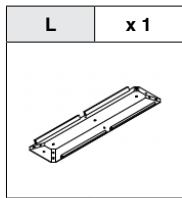
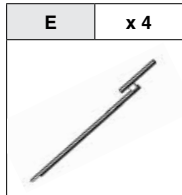

# ASSEMBLAGE / ASSEMBLY

## Étape / Step 8

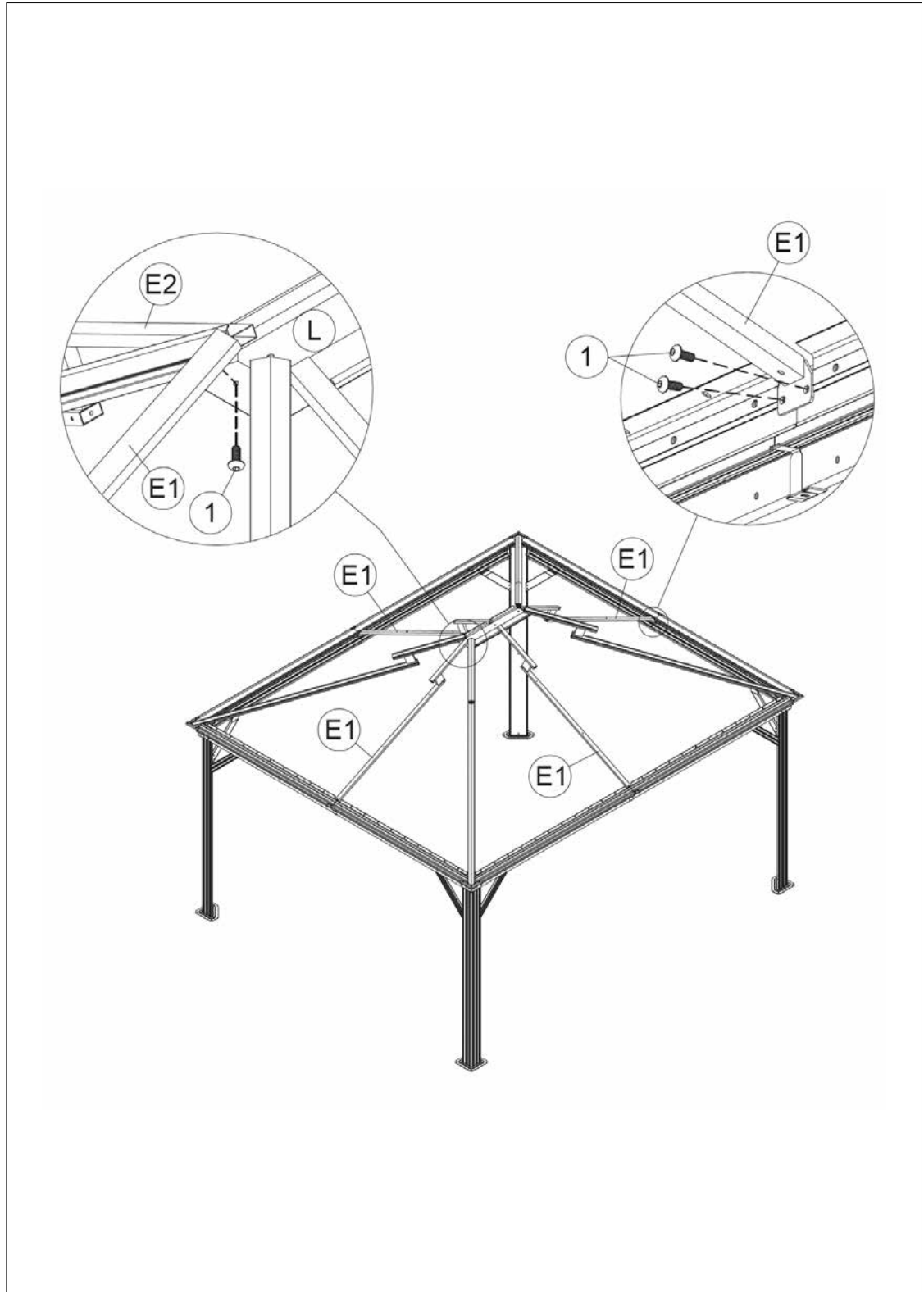
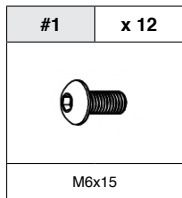
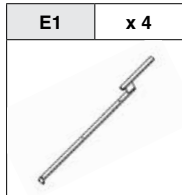

# ASSEMBLAGE / ASSEMBLY

## Étape / Step 9

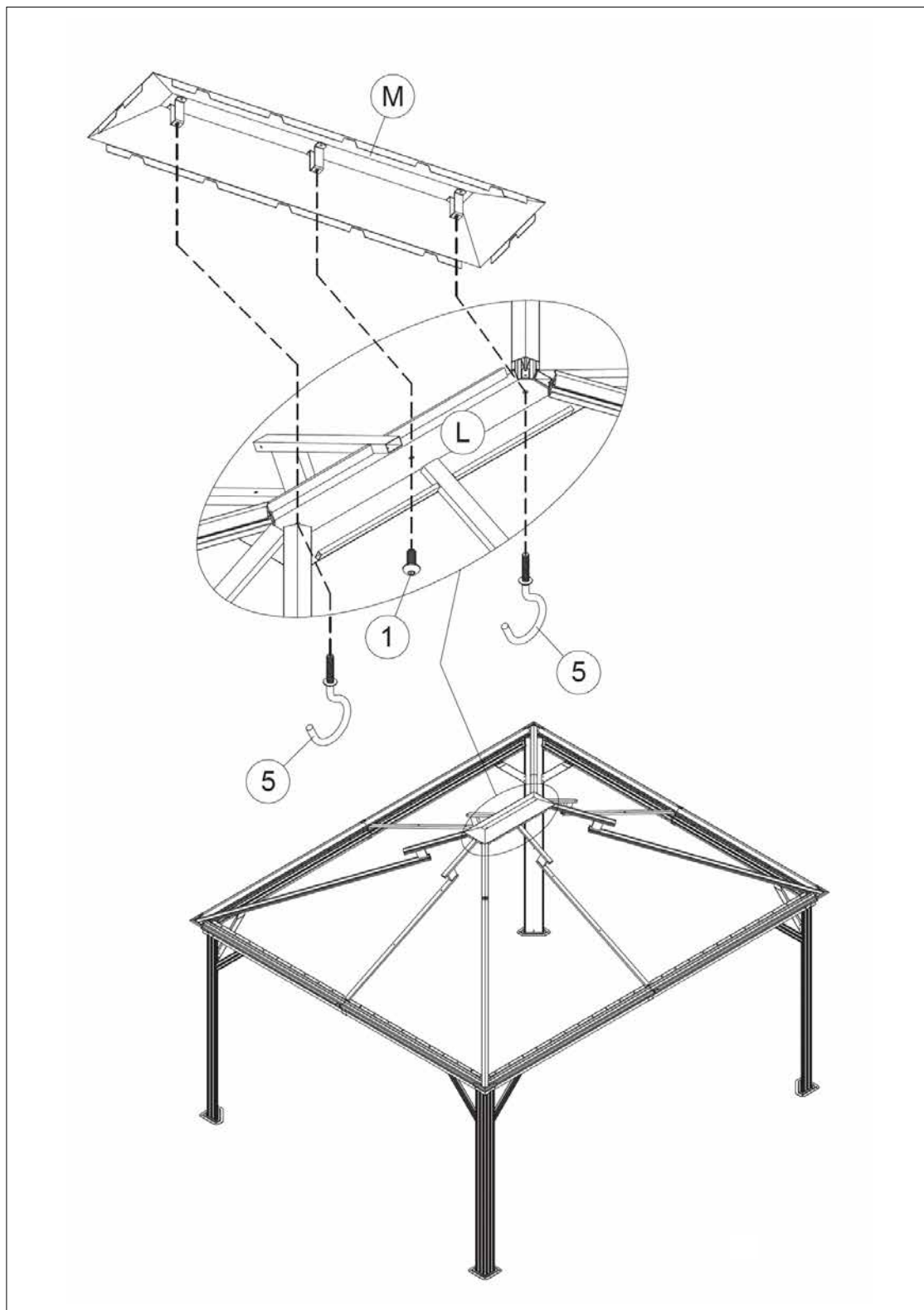
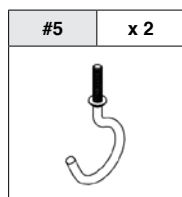
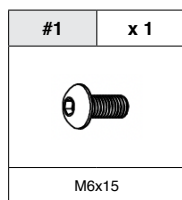
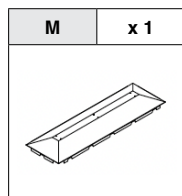

# ASSEMBLAGE / ASSEMBLY

Étape / Step 10

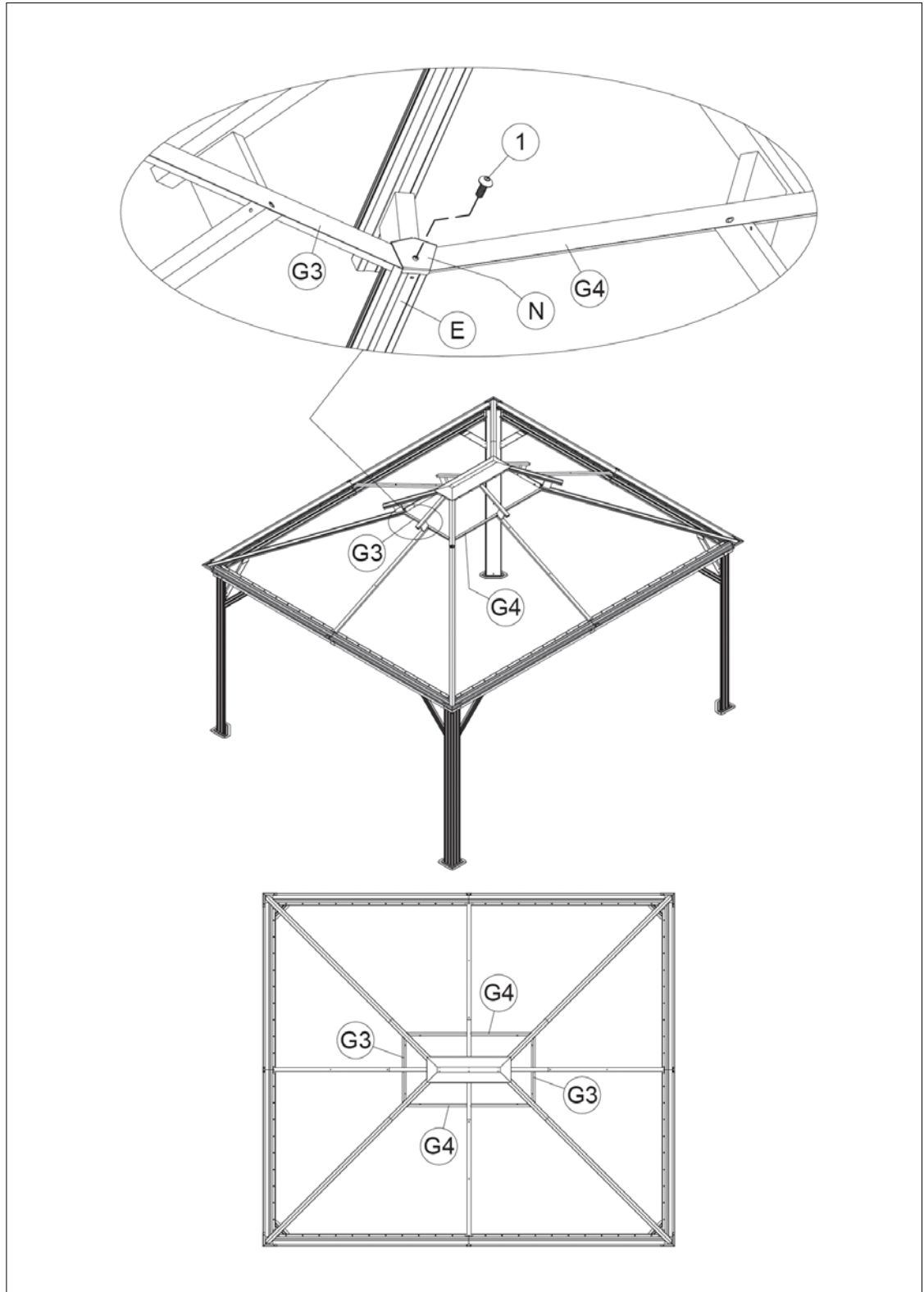
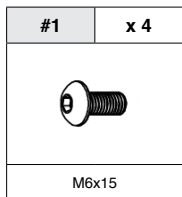
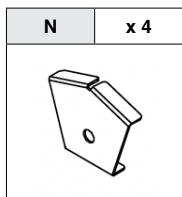
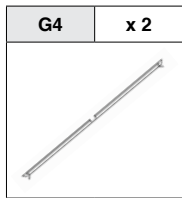
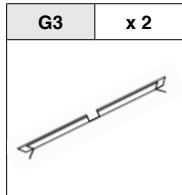



# ASSEMBLAGE / ASSEMBLY

## Étape / Step 11

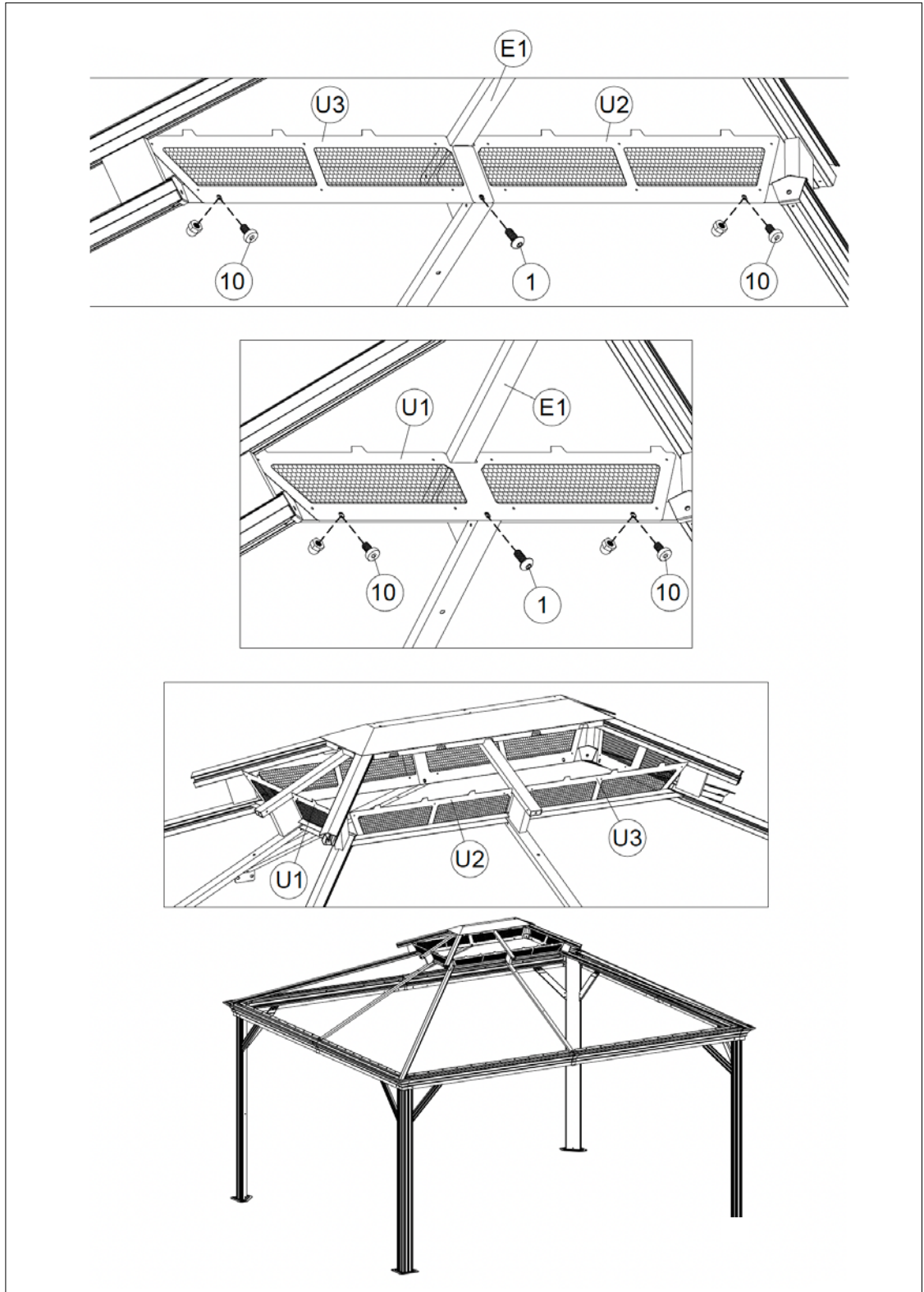
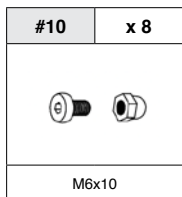
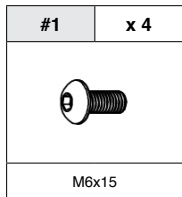
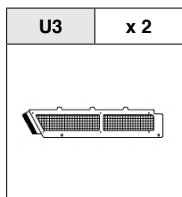
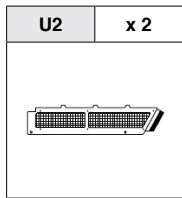
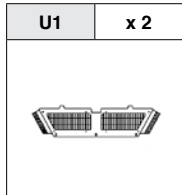

# ASSEMBLAGE / ASSEMBLY

Étape / Step 12

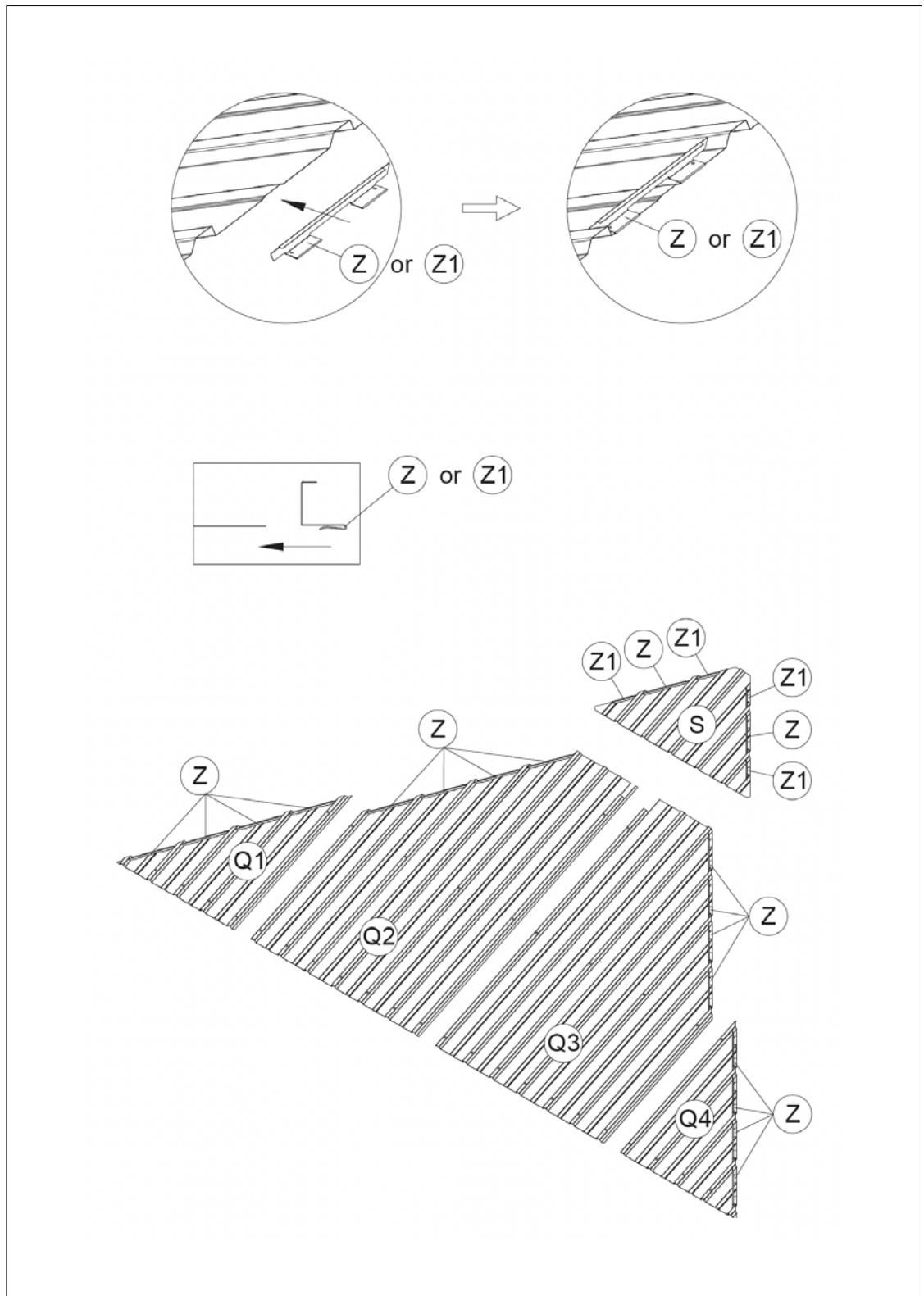
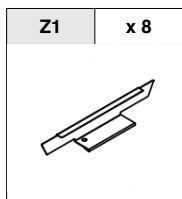
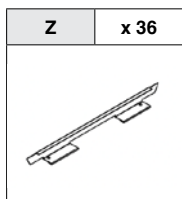
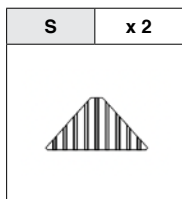
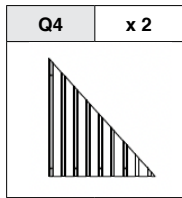
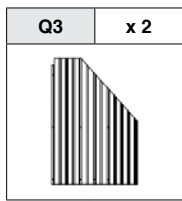
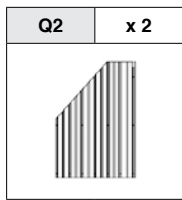
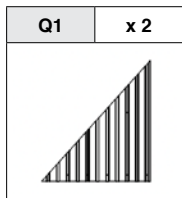

# ASSEMBLAGE / ASSEMBLY

Étape / Step 13

<b>R1</b>	<b>x 2</b>
<b>R2</b>	<b>x 2</b>
<b>R3</b>	<b>x 2</b>
<b>R4</b>	<b>x 2</b>
<b>S1</b>	<b>x 2</b>
<b>S2</b>	<b>x 2</b>
<b>Z</b>	<b>x 36</b>
<b>Z1</b>	<b>x 4</b>

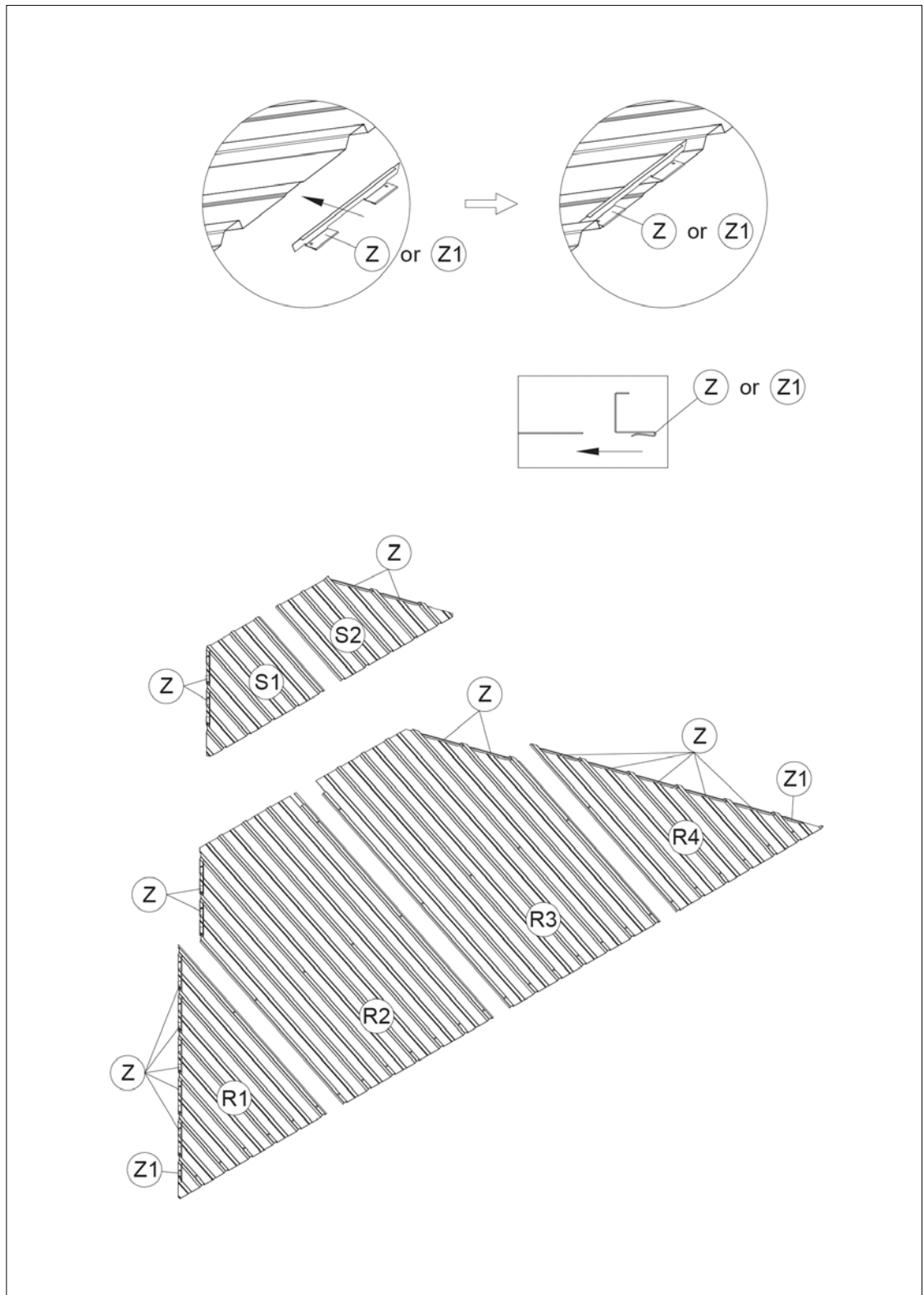

# ASSEMBLAGE / ASSEMBLY

Étape / Step 14

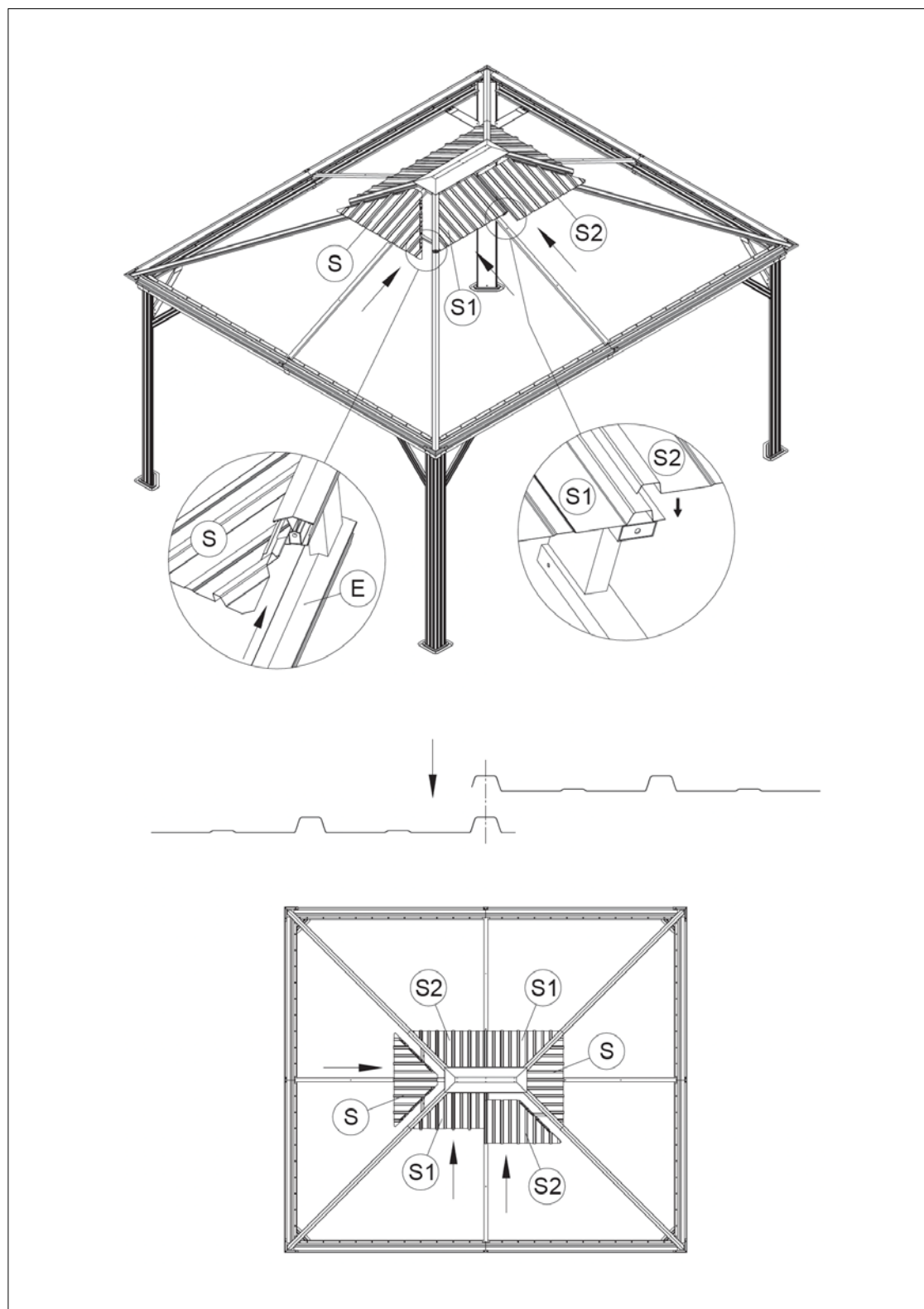



# ASSEMBLAGE / ASSEMBLY

Étape / Step 15

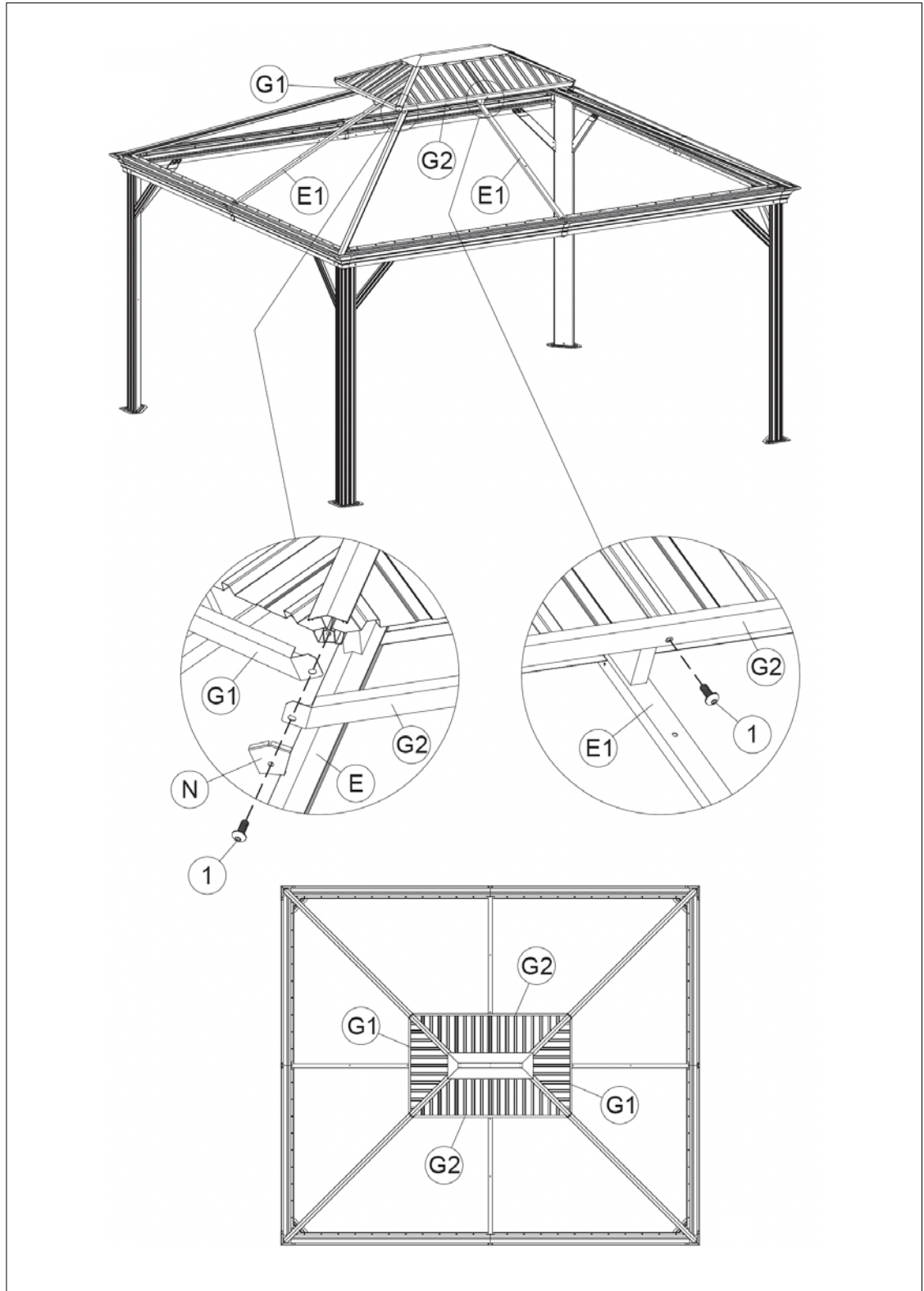
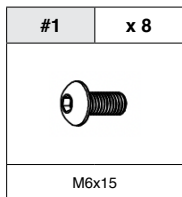
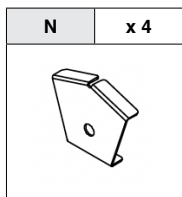
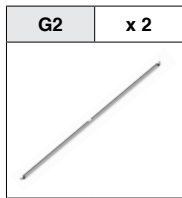
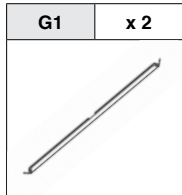

# ASSEMBLAGE / ASSEMBLY

Étape / Step 16

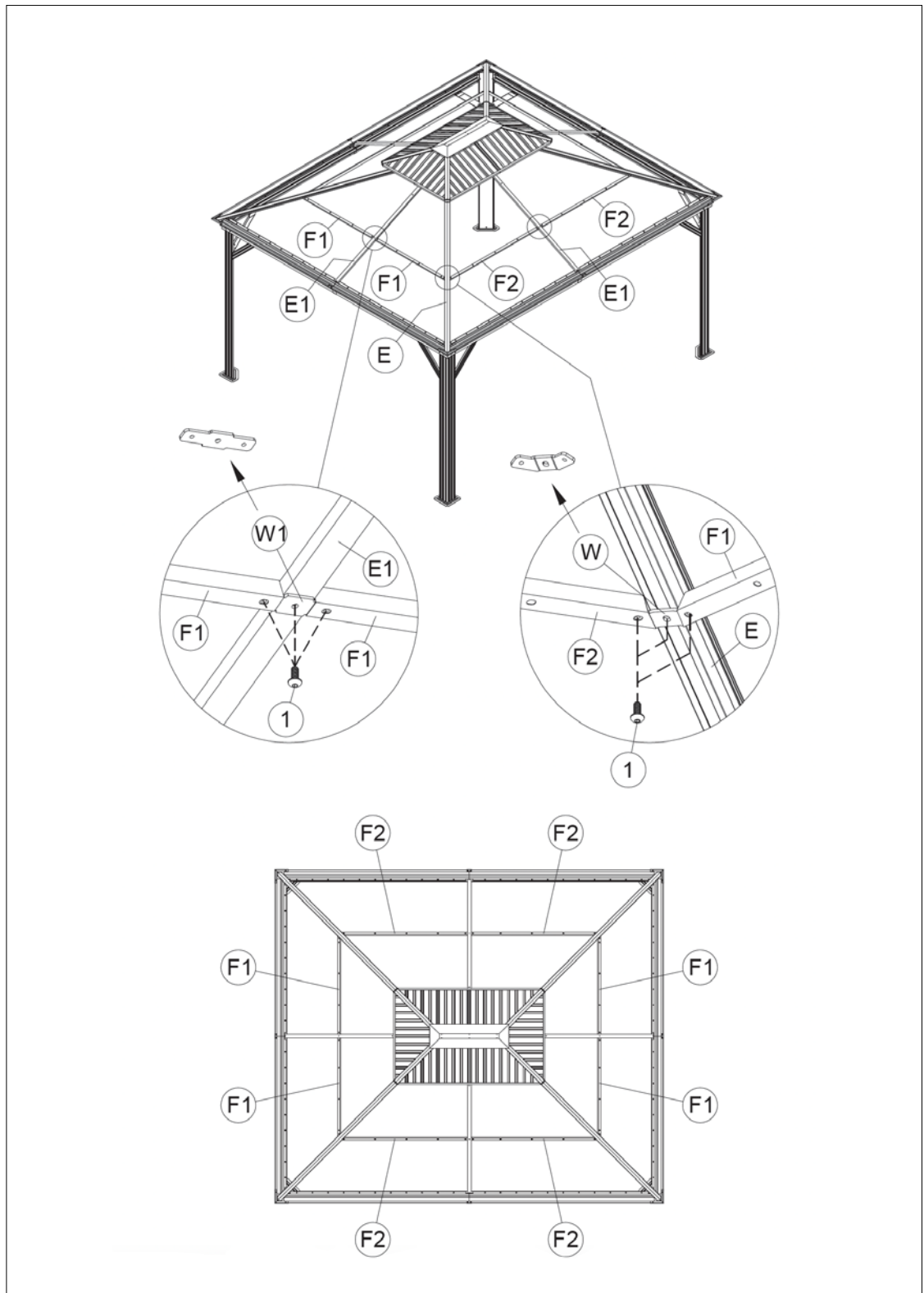
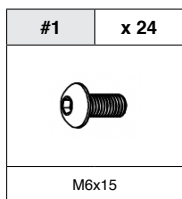
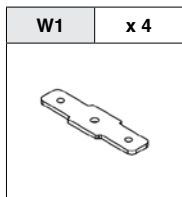
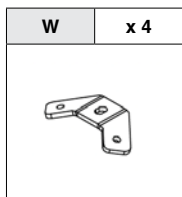
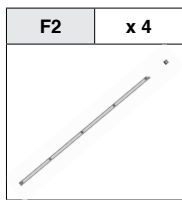
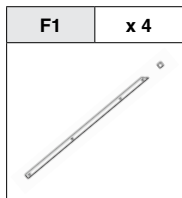



# ASSEMBLAGE / ASSEMBLY

Étape / Step 17

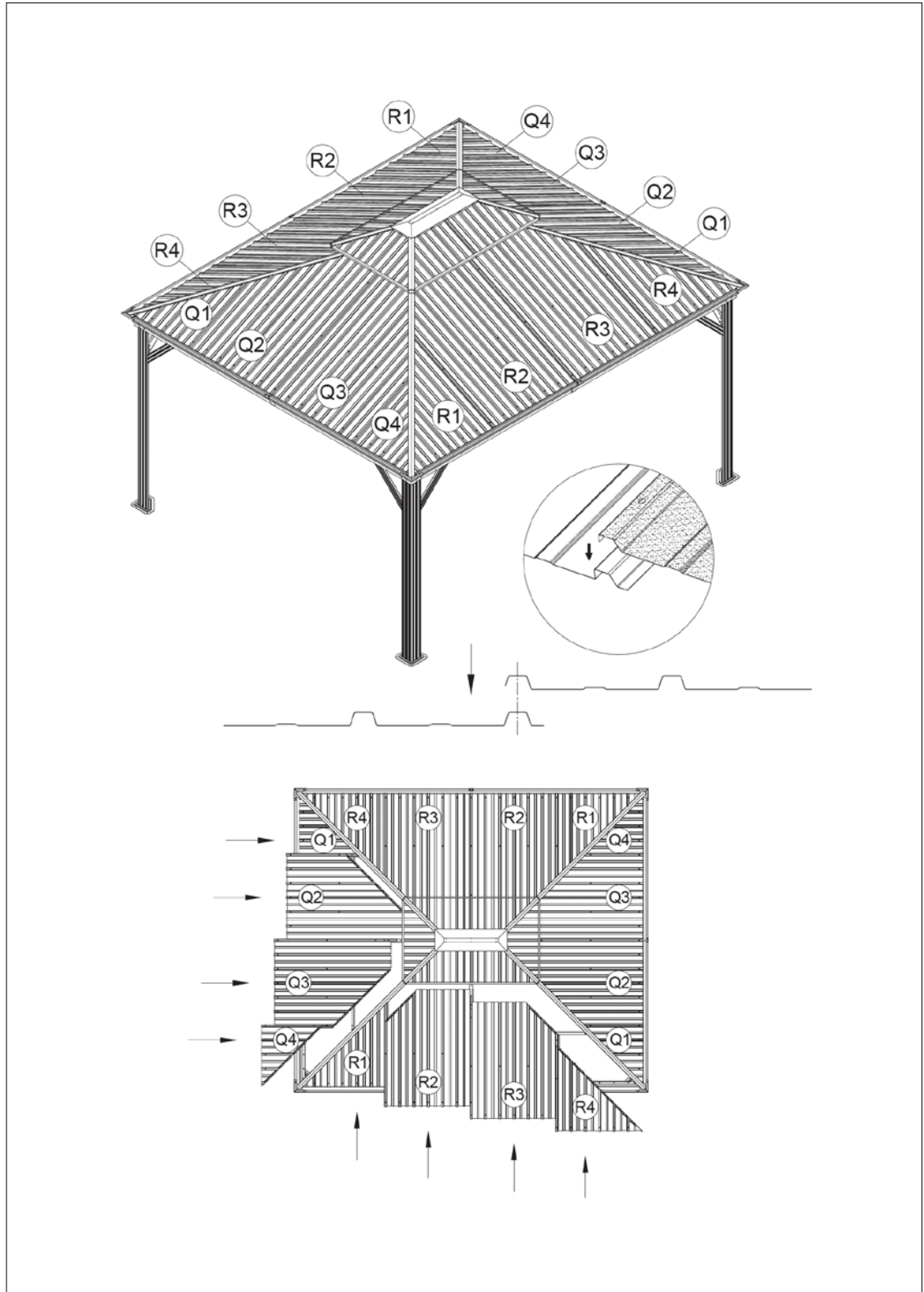

# ASSEMBLAGE / ASSEMBLY

Étape / Step 18

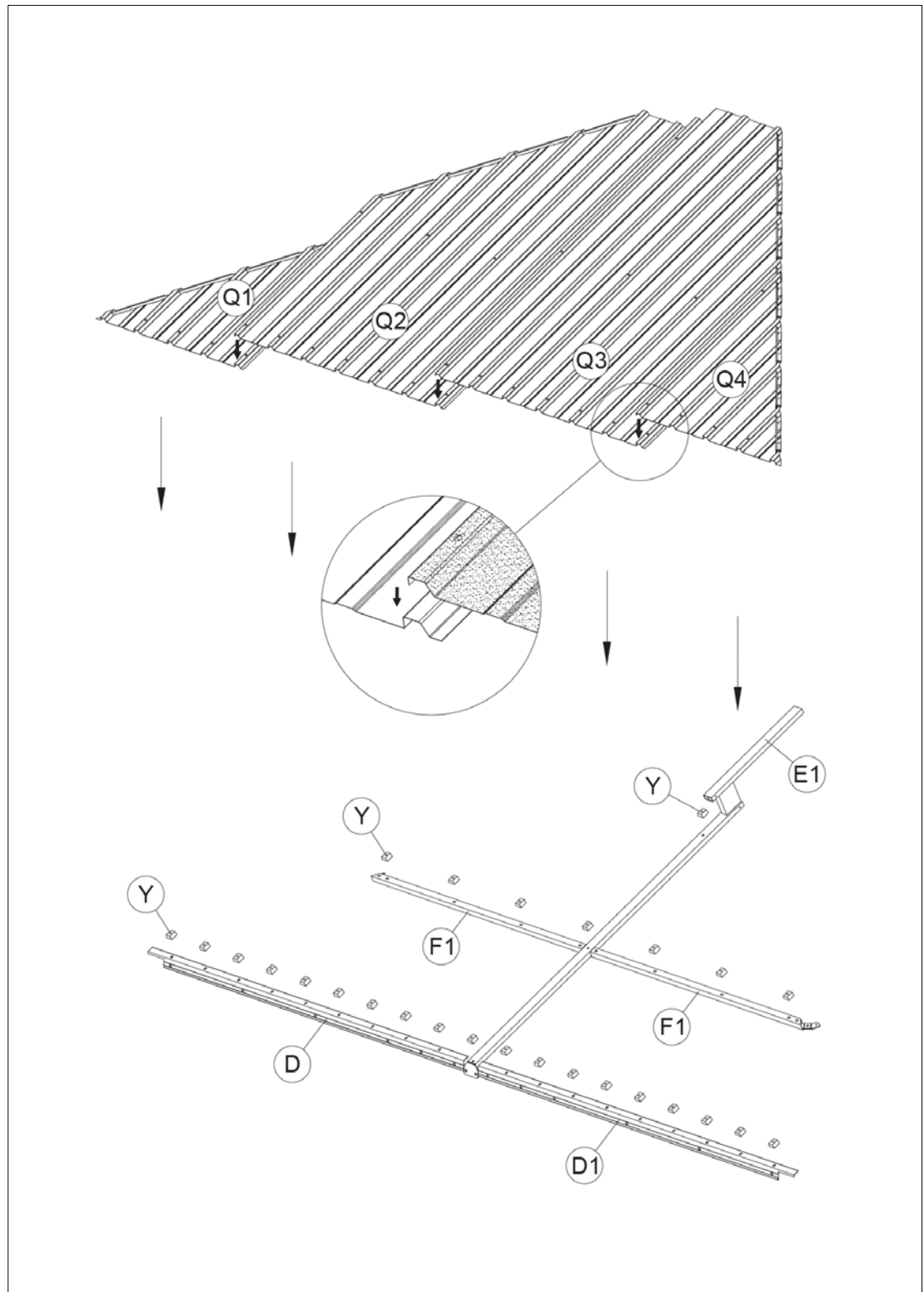

# ASSEMBLAGE / ASSEMBLY

Étape / Step 19

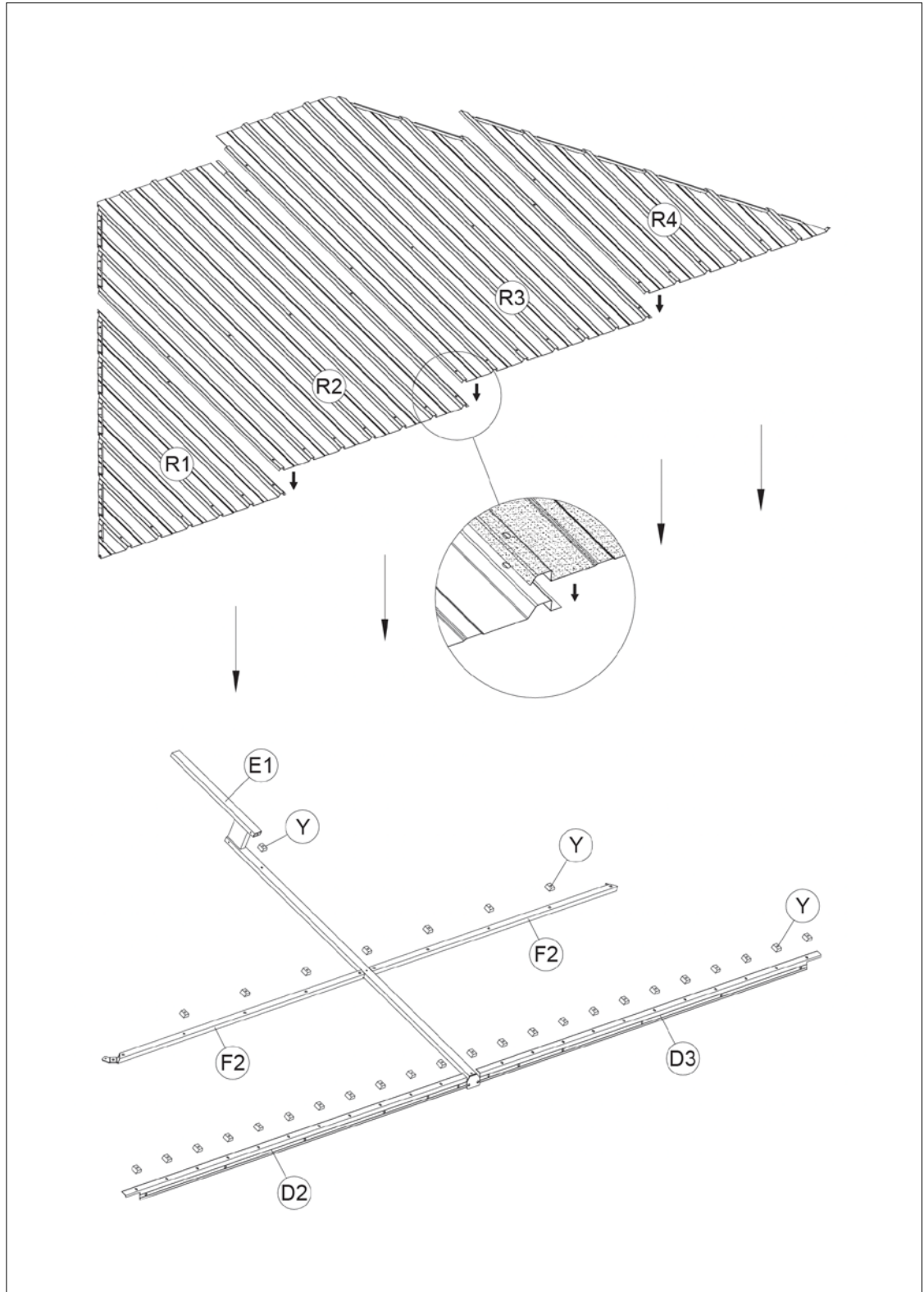

# ASSEMBLAGE / ASSEMBLY

Étape / Step 20

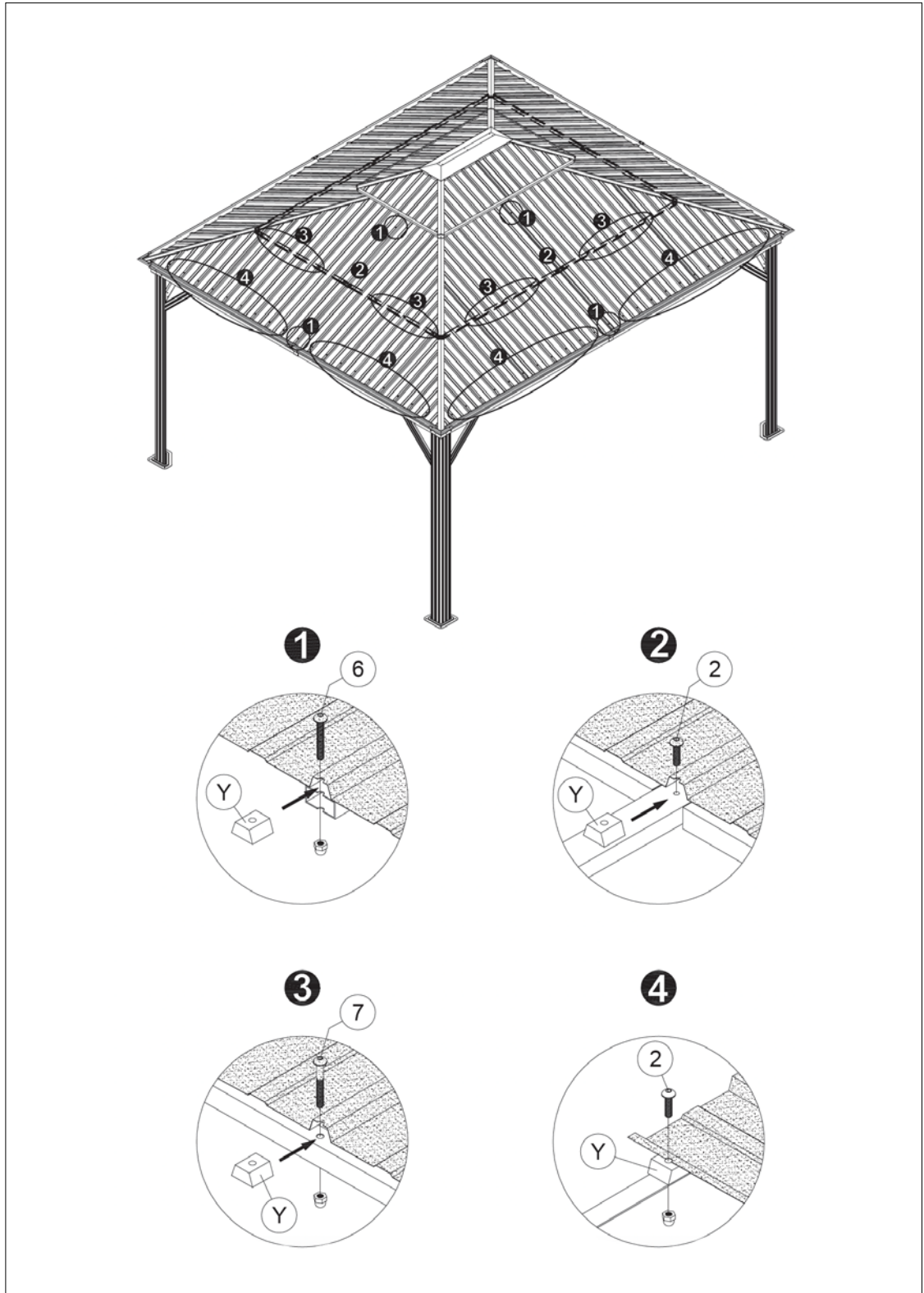
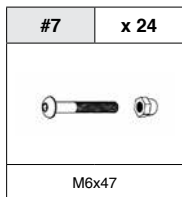
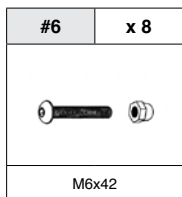
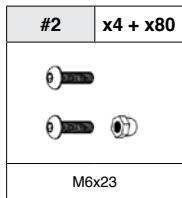
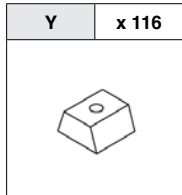

# ASSEMBLAGE / ASSEMBLY

Étape / Step 21

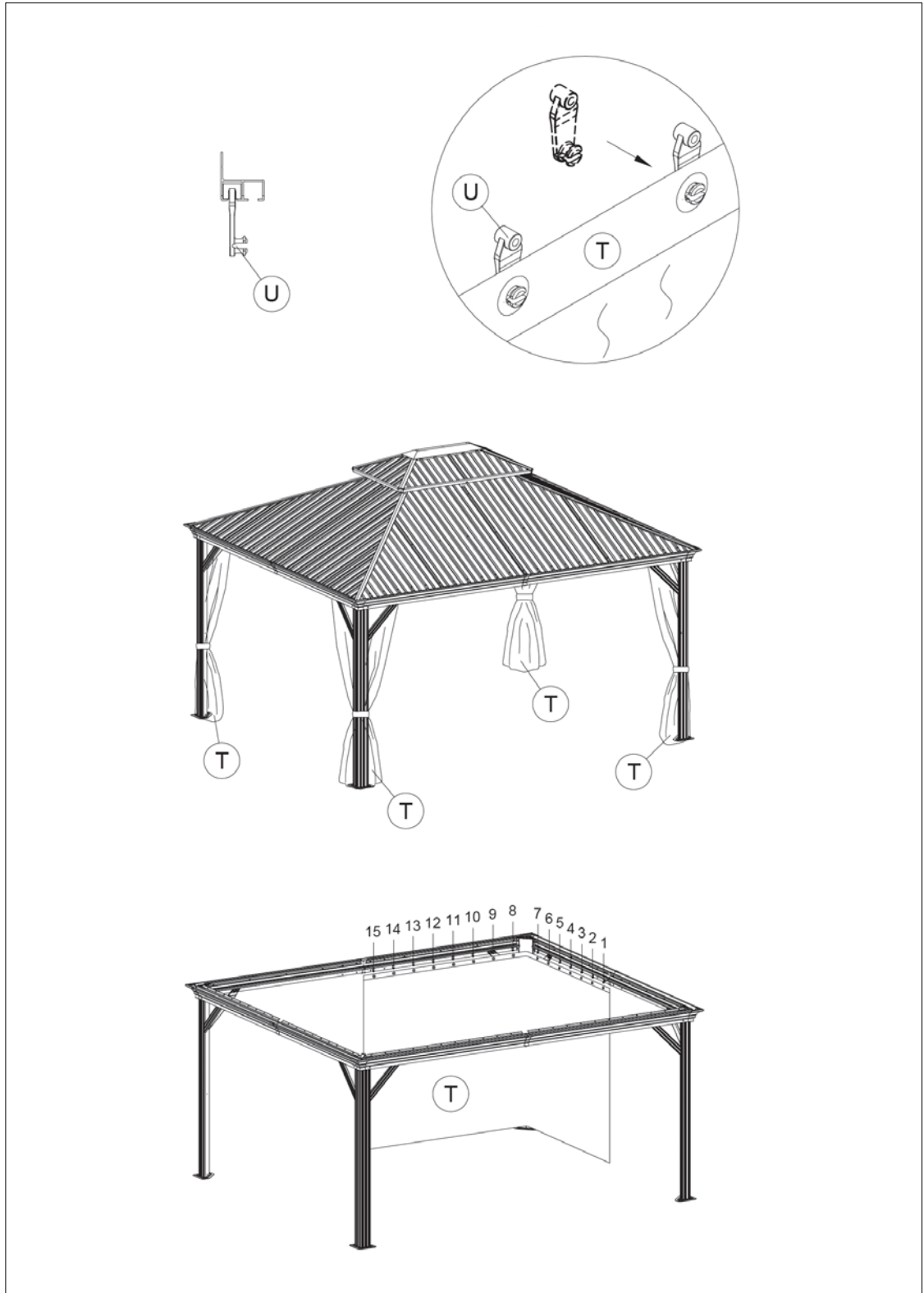
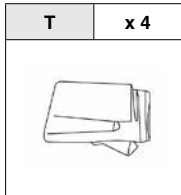



# ASSEMBLAGE / ASSEMBLY

Étape / Step 22

