

PAVILLON PORT ROYAL 10' X 12'

10' x 12' Port Royal Pavilion

Référence / Reference: 27841

GUIDE D'ASSEMBLAGE



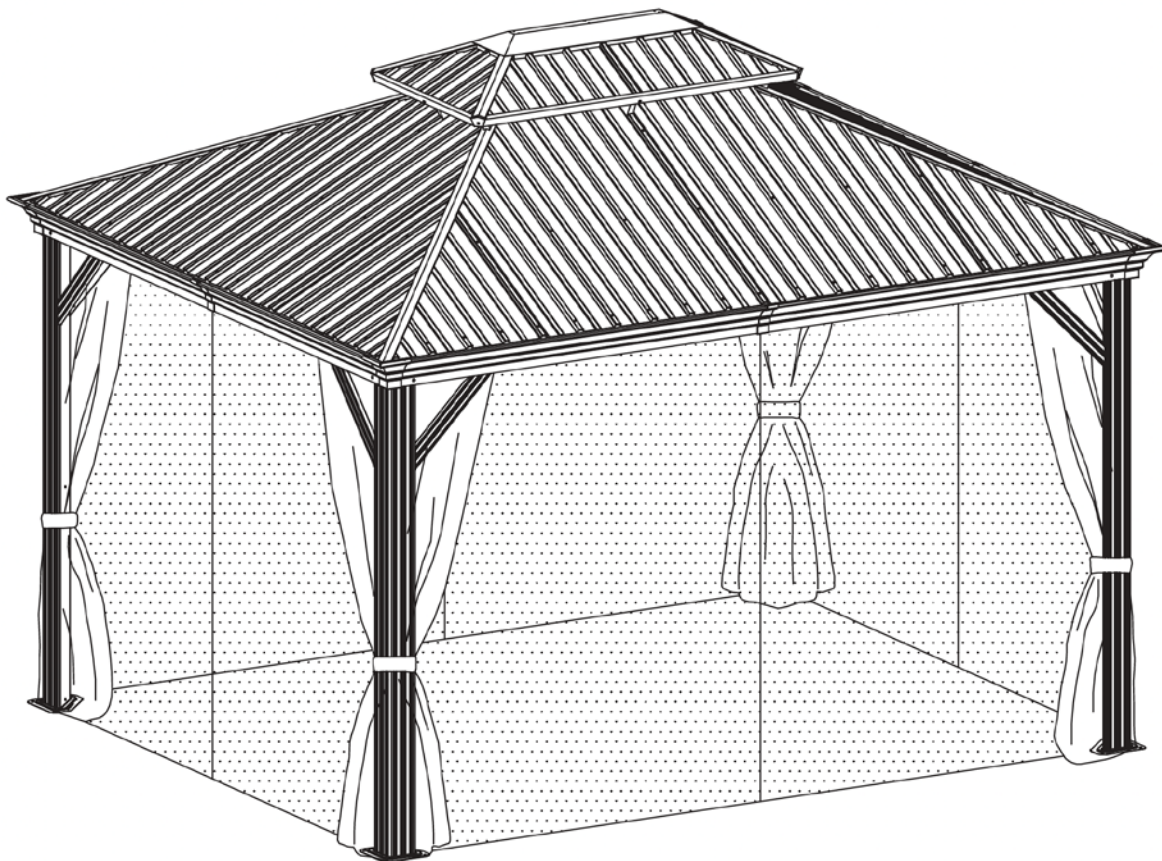







Assembly Instructions









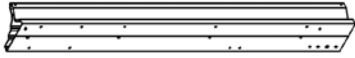
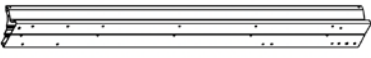

POUR TOUTE ASSISTANCE,
CONTACTEZ VOTRE DÉTAILLANT.
For assistance, contact your retailer.

PRÉASSEMBLAGE / PRE-ASSEMBLY



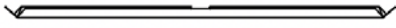









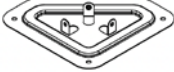
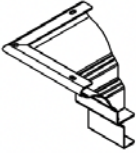

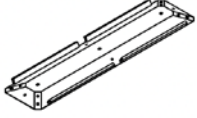
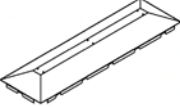

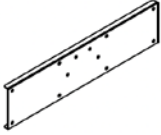
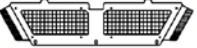

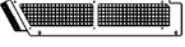
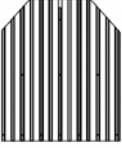
Liste des pièces (1) / Parts List (1)

| Pièce/ Part | Description | Qté / Qty |
|----------------|---|--------------|
| A |  | x 4 |
| B1 |  | x 2 |
| B3 |  | x 2 |
| C1 |  | x 2 |
| C3 |  | x 2 |
| D1 |  | x 2 |
| D3 |  | x 2 |
| E1 |  | x 4 |
| F2 |  | x 4 |
| G2 |  | x 2 |
| G4 |  | x 2 |

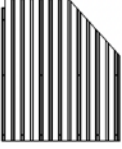
| Pièce/ Part | Description | Qté / Qty |
|----------------|--|--------------|
| B |  | x 2 |
| B2 |  | x 2 |
| C |  | x 2 |
| C2 |  | x 2 |
| D |  | x 2 |
| D2 |  | x 2 |
| E |  | x 4 |
| F1 |  | x 4 |
| G1 |  | x 2 |
| G3 |  | x 2 |



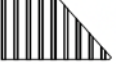

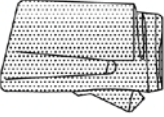





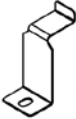
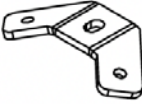
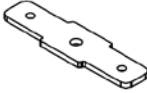
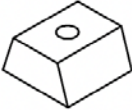
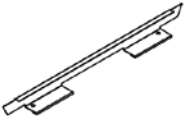
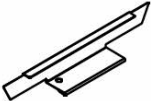

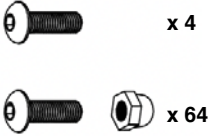
PRÉASSEMBLAGE / PRE-ASSEMBLY

Liste des pièces (2) / Parts List (2)

| | | | | | | | | | |
|---|------------|---|------------|---|------------|---|------------|---|------------|
| H | x 4 | H1 | x 4 | J | x 4 | K | x 4 | K1 | x 4 |
|  | |  | |  | |  | |  | |
| L | x 1 | M | x 1 | N | x 8 | P | x 4 | U1 | x 2 |
|  | |  | |  | |  | |  | |
| U2 | x 2 | U3 | x 2 | Q | x 2 | Q1 | x 2 | Q2 | x 2 |
|  | |  | |  | |  | |  | |
| R1 | x 2 | R2 | x 2 | R3 | x 2 | R4 | x 2 | S | x 2 |
|  | |  | |  | |  | |  | |
| S1 | x 2 | S2 | x 2 | T | x 4 | T1 | x 4 | | |
|  | |  | |  | |  | | | |

PRÉASSEMBLAGE / PRE-ASSEMBLY

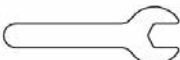
Liste des pièces (3) / Parts List (3)

| | | | | | | | | | |
|---|--------------|---|-------------|---|--------------|--|-------------------|---|-------------|
| U | x 104 | V | x 4 | W | x 4 | W1 | x 4 | Y | x 96 |
|  | |  | |  | |  | |  | |
| Z | x 56 | Z1 | x 16 | #1 | x 229 | #2 | x 4 + x 64 | #3 | x 4 |
|  | |  | |  | |  | |  | |
| | | | | M6x15 | | M6x23 | | M5x12 | |
| #4 | x 24 | #5 | x 2 | #6 | x 8 | #7 | x 20 | #8 | x 8 |
|  | |  | |  | |  | |  | |
| ST4.8x12 | | | | M6x42 | | M6x47 | | | |
| #10 | x 8 | x 1 | x 1 | x 1 | x 1 | x 12 | | | |
|  | |  | |  | |  | | | |
| M6x10 | | | | | | | | | |

ASSEMBLAGE / ASSEMBLY

Étape / Step 1

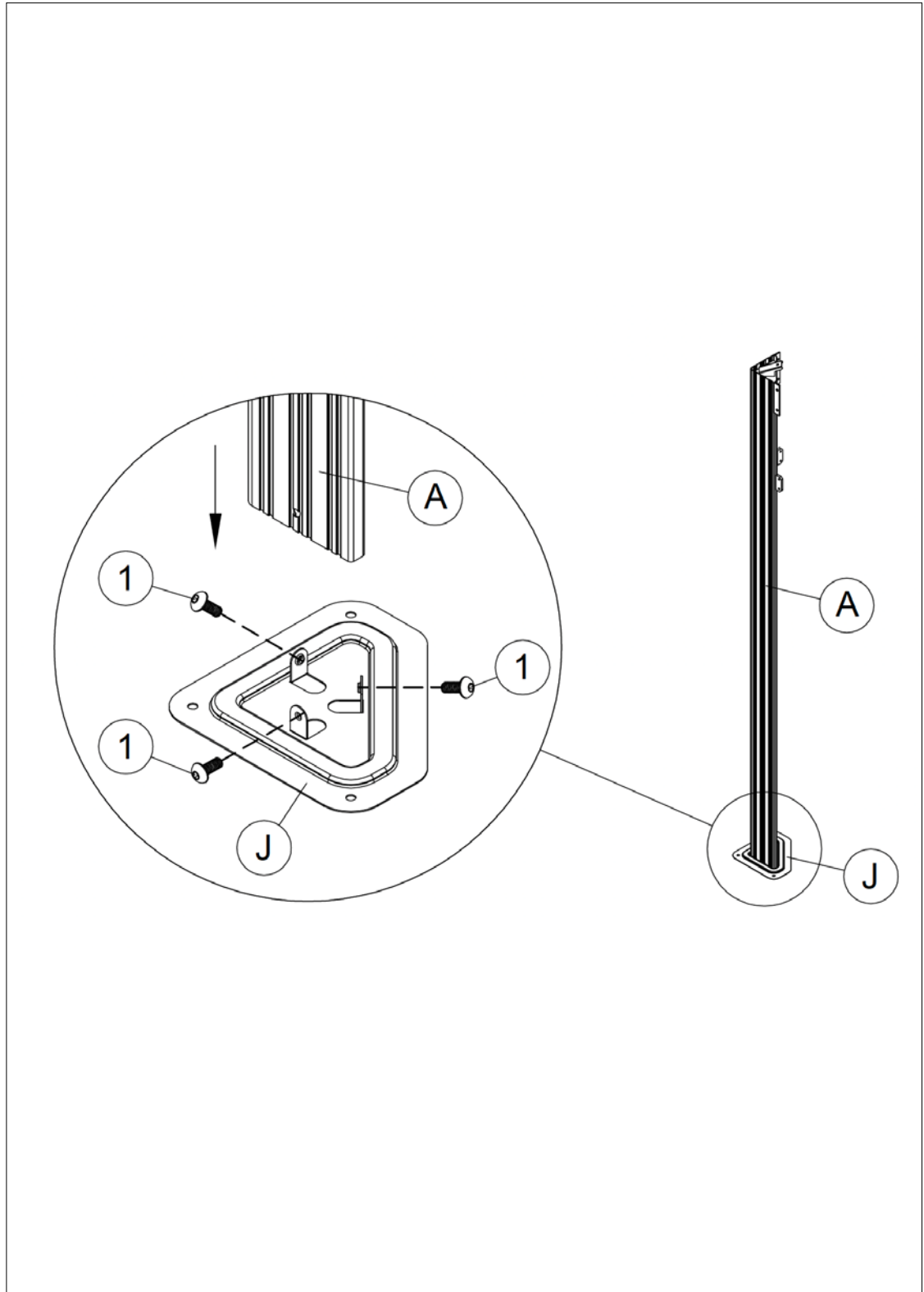
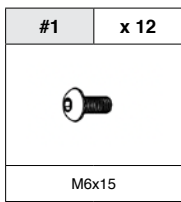
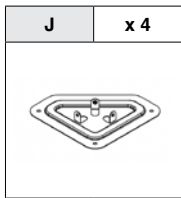
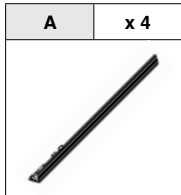

ASSEMBLAGE / ASSEMBLY

Étape / Step 2

| | |
|-----------|-------------|
| B | x 2 |
| | |
| B1 | x 2 |
| | |
| C | x 2 |
| | |
| C1 | x 2 |
| | |
| D | x 2 |
| | |
| D1 | x 2 |
| | |
| P | x 2 |
| | |
| #1 | x 44 |
| | |
| M6x15 | |

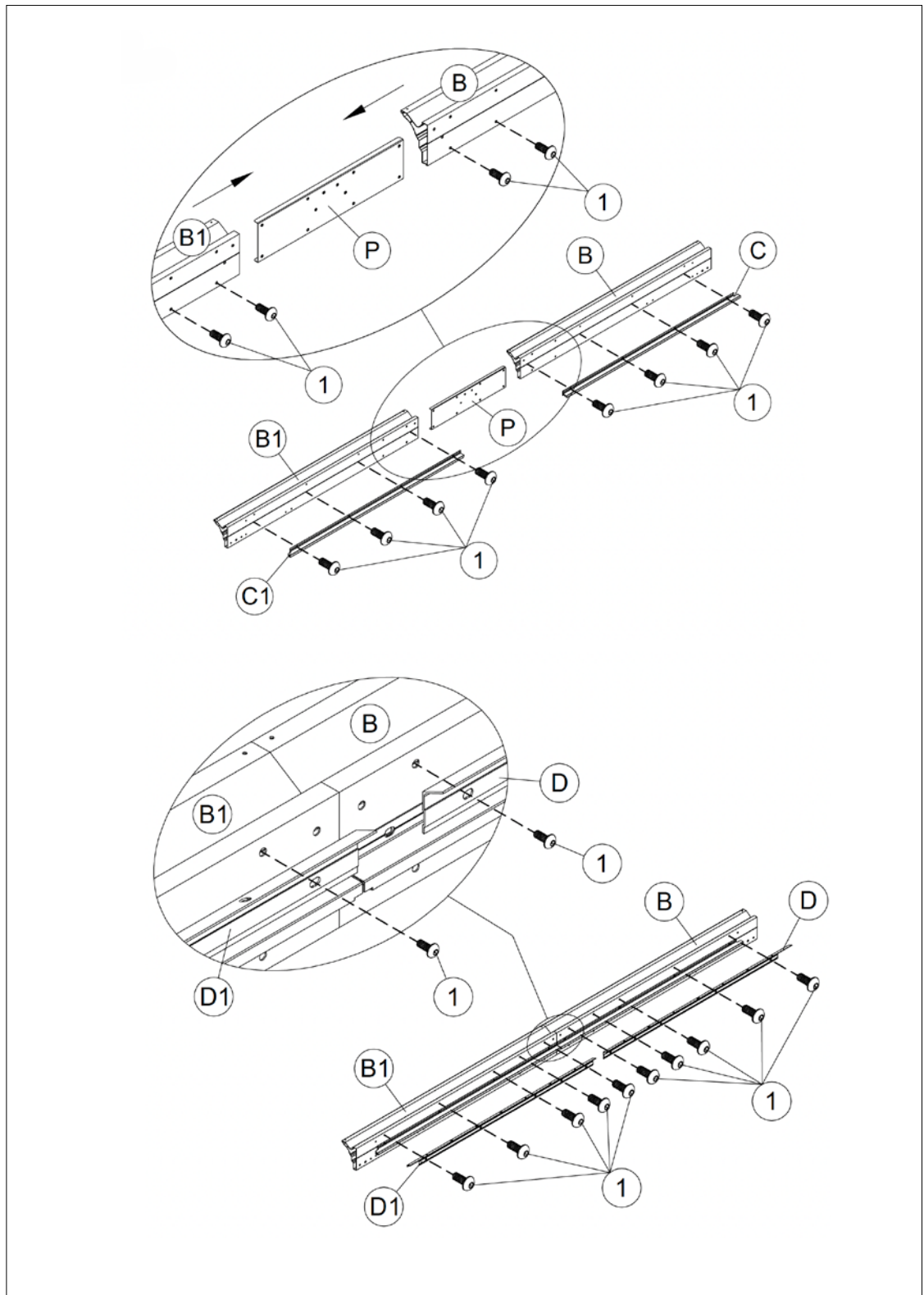

ASSEMBLAGE / ASSEMBLY

Étape / Step 3

| | |
|-----------|-------------|
| B2 | x 2 |
| | |
| B3 | x 2 |
| | |
| C2 | x 2 |
| | |
| C3 | x 2 |
| | |
| D2 | x 2 |
| | |
| D3 | x 2 |
| | |
| P | x 2 |
| | |
| #1 | x 52 |
| | |
| M6x15 | |

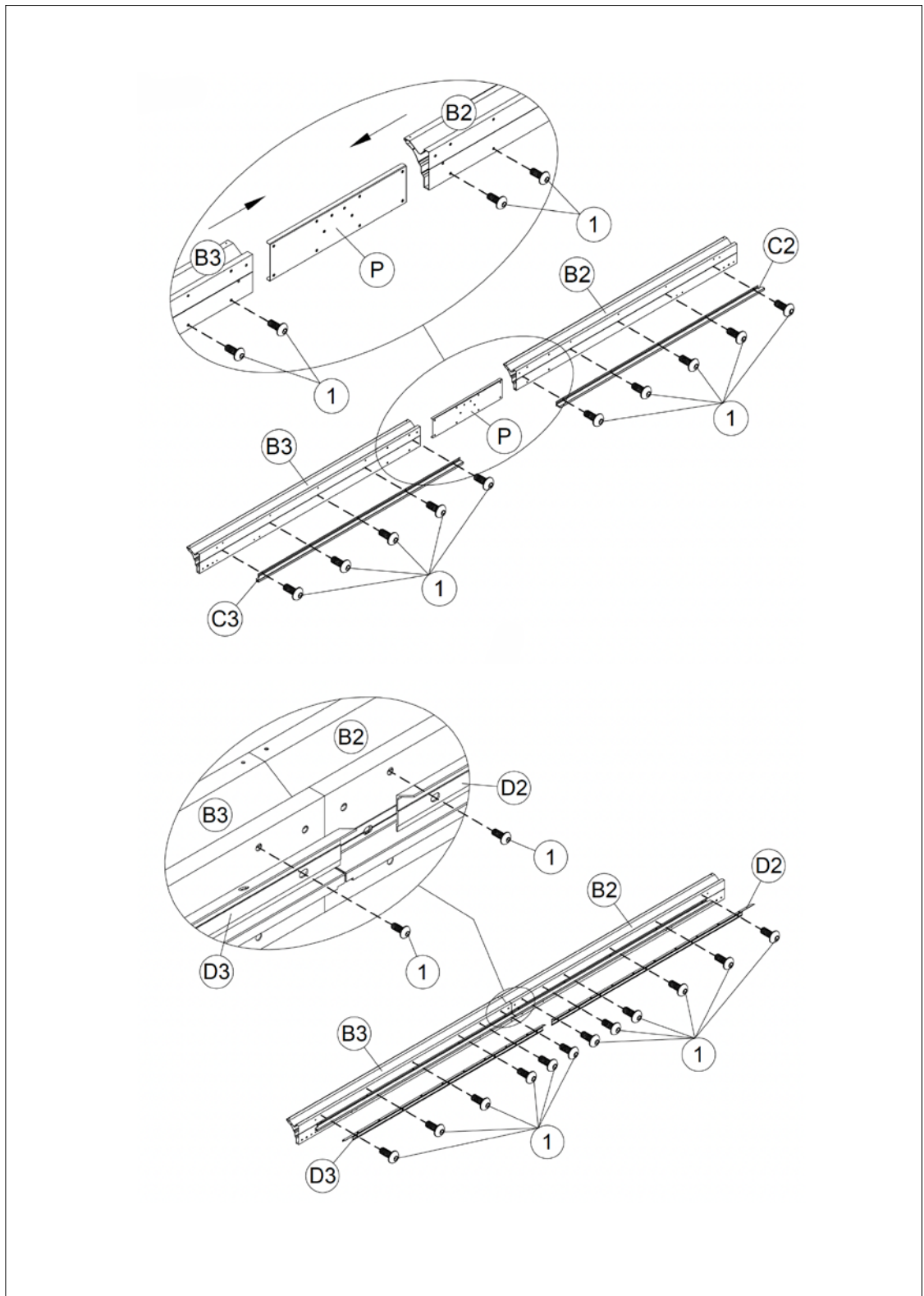

ASSEMBLAGE / ASSEMBLY

Étape / Step 4

| | |
|---|------|
| #1 | x 24 |
|  | |
| M6x15 | |

| | |
|---|-----|
| #8 | x 8 |
|  | |

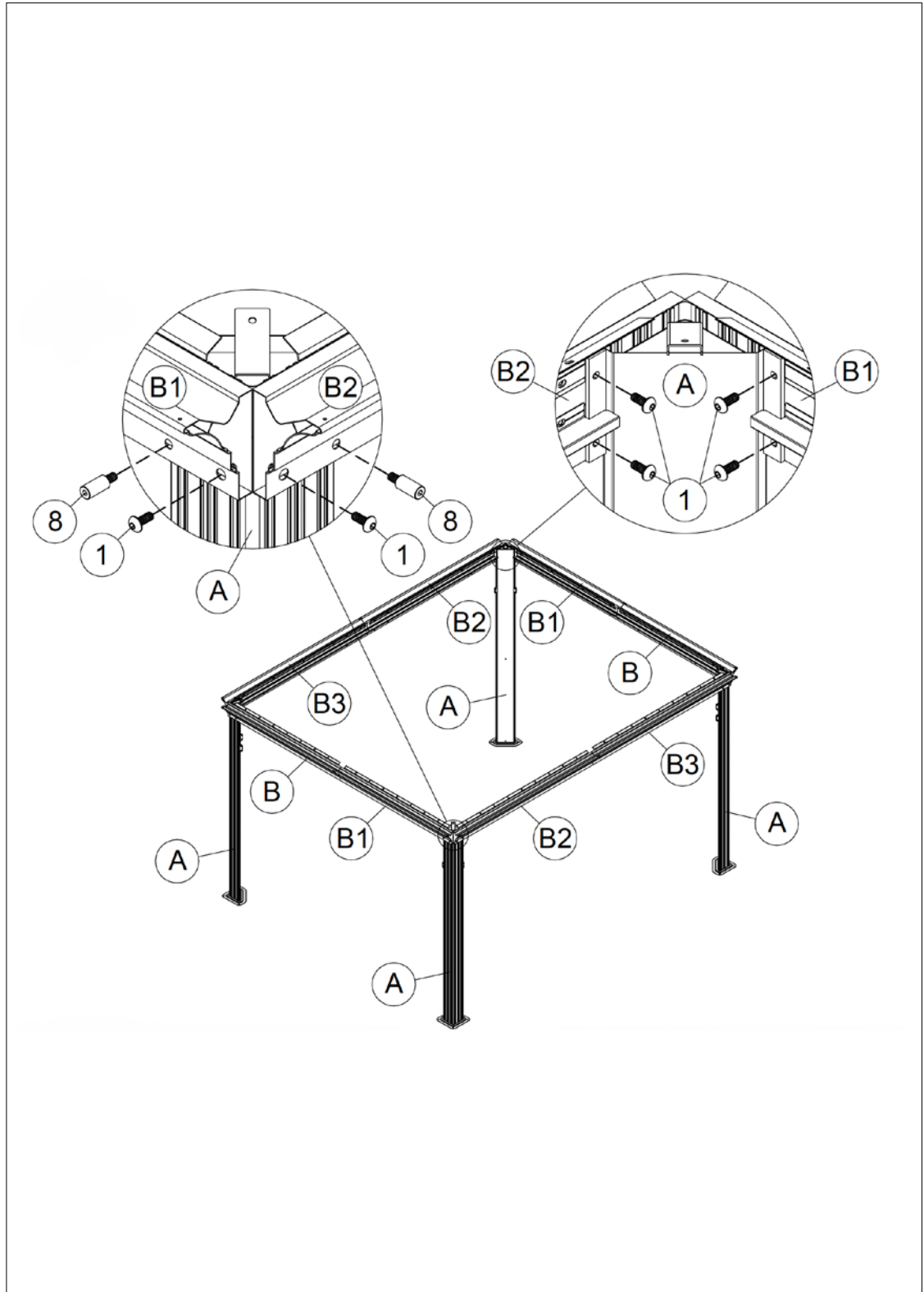

ASSEMBLAGE / ASSEMBLY

Étape / Step 5

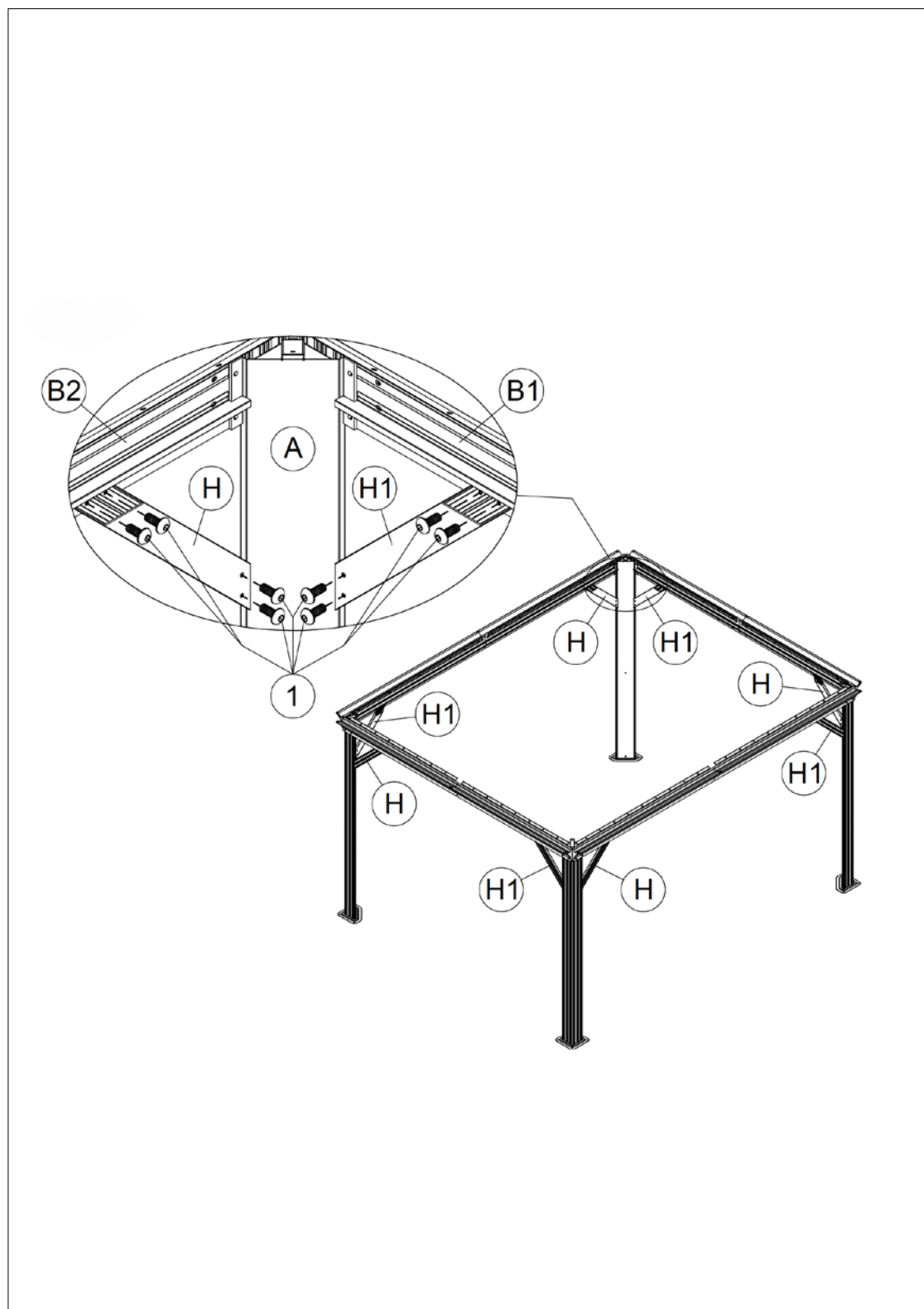
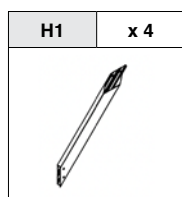
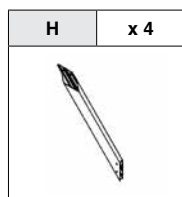
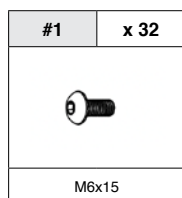

ASSEMBLAGE / ASSEMBLY

Étape / Step 6

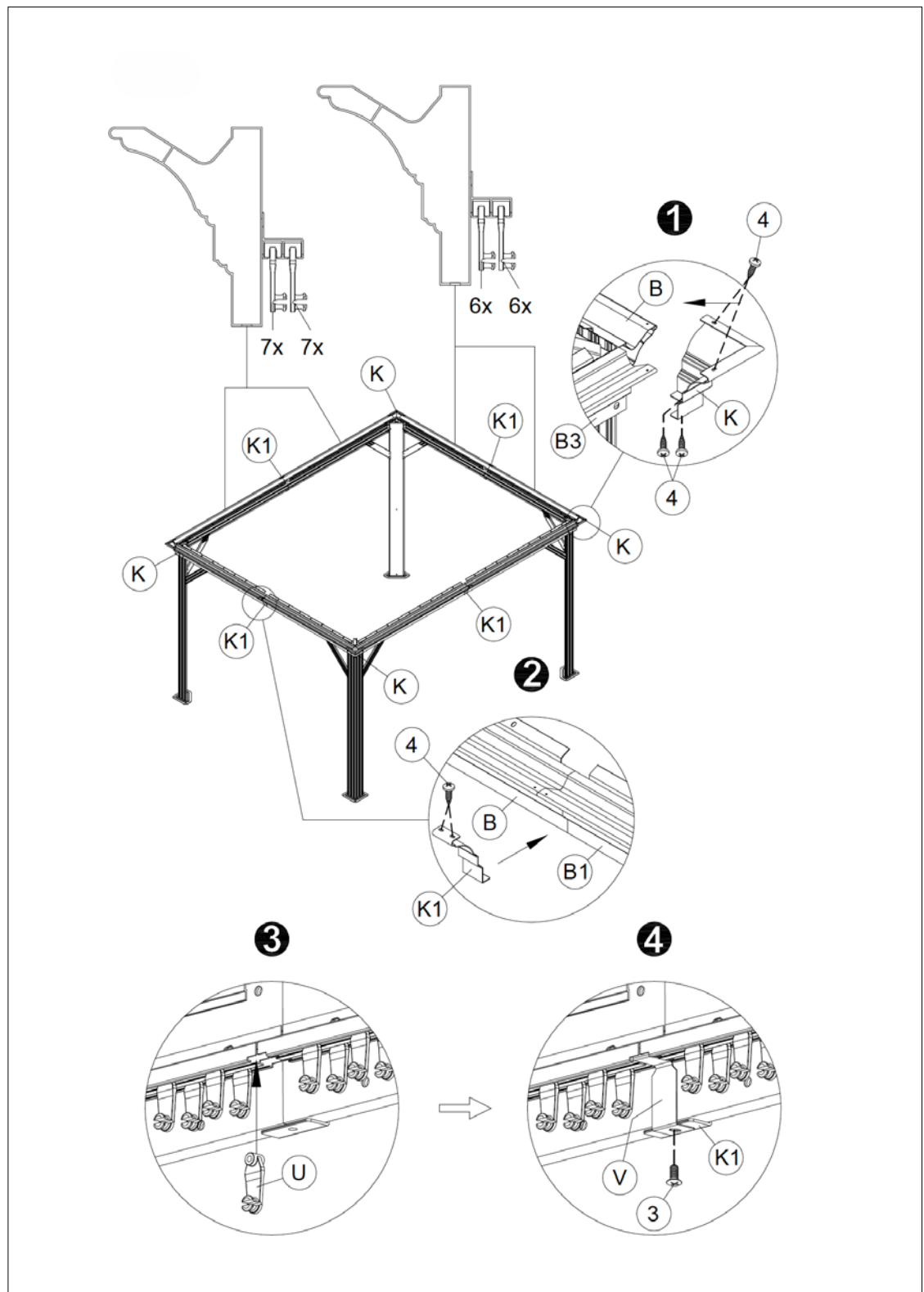
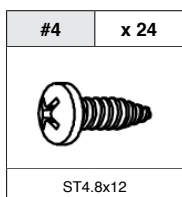
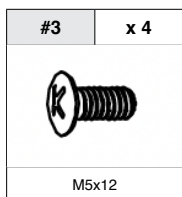
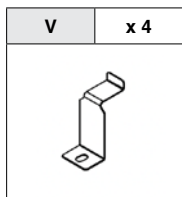
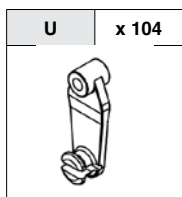
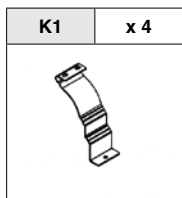
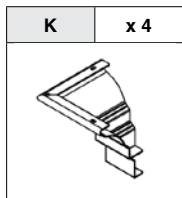

ASSEMBLAGE / ASSEMBLY

Étape / Step 7

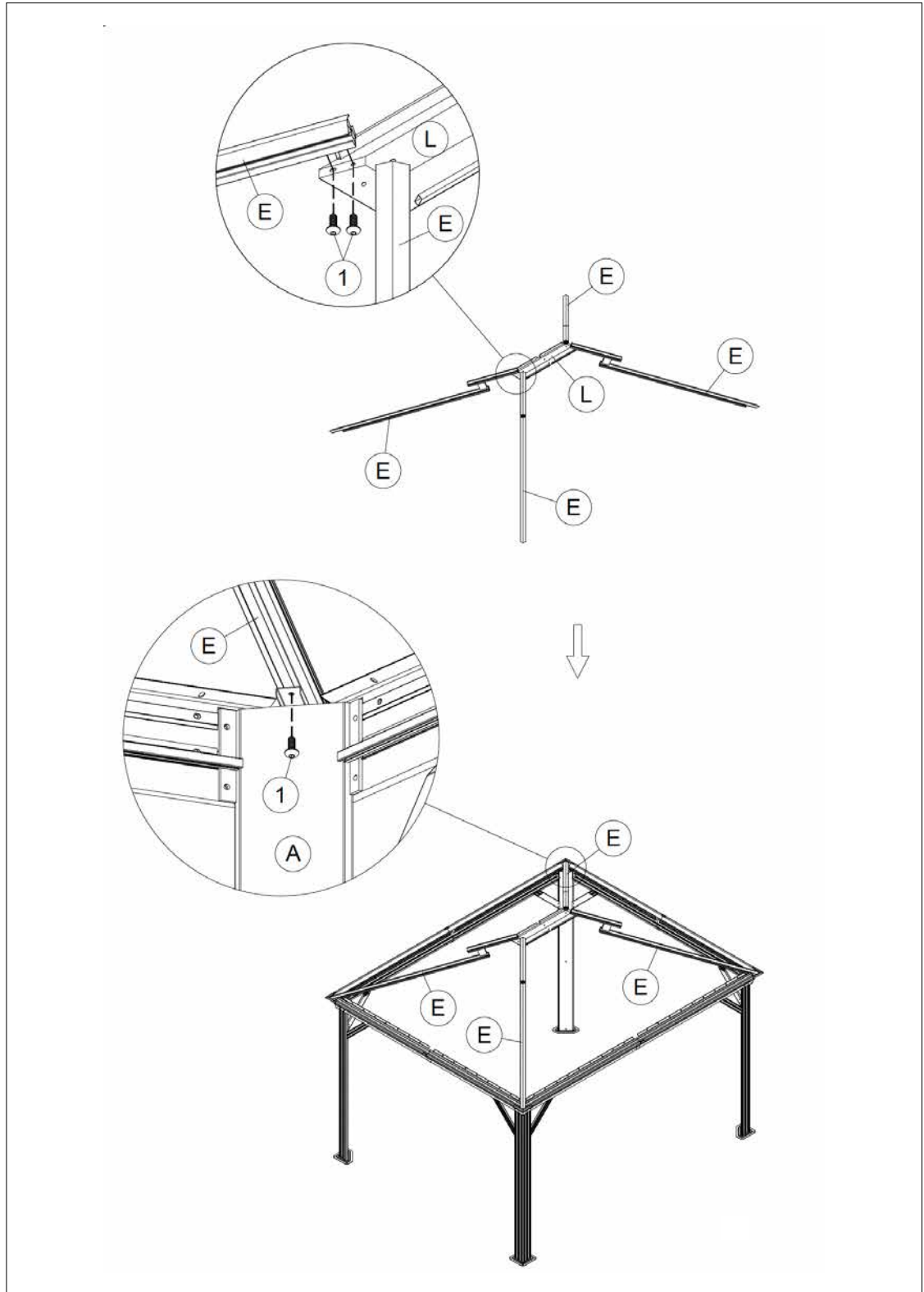
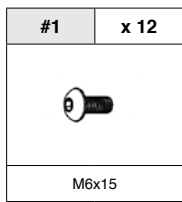
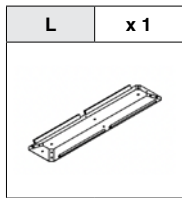
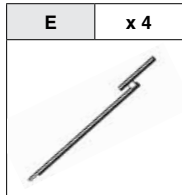

ASSEMBLAGE / ASSEMBLY

Étape / Step 8

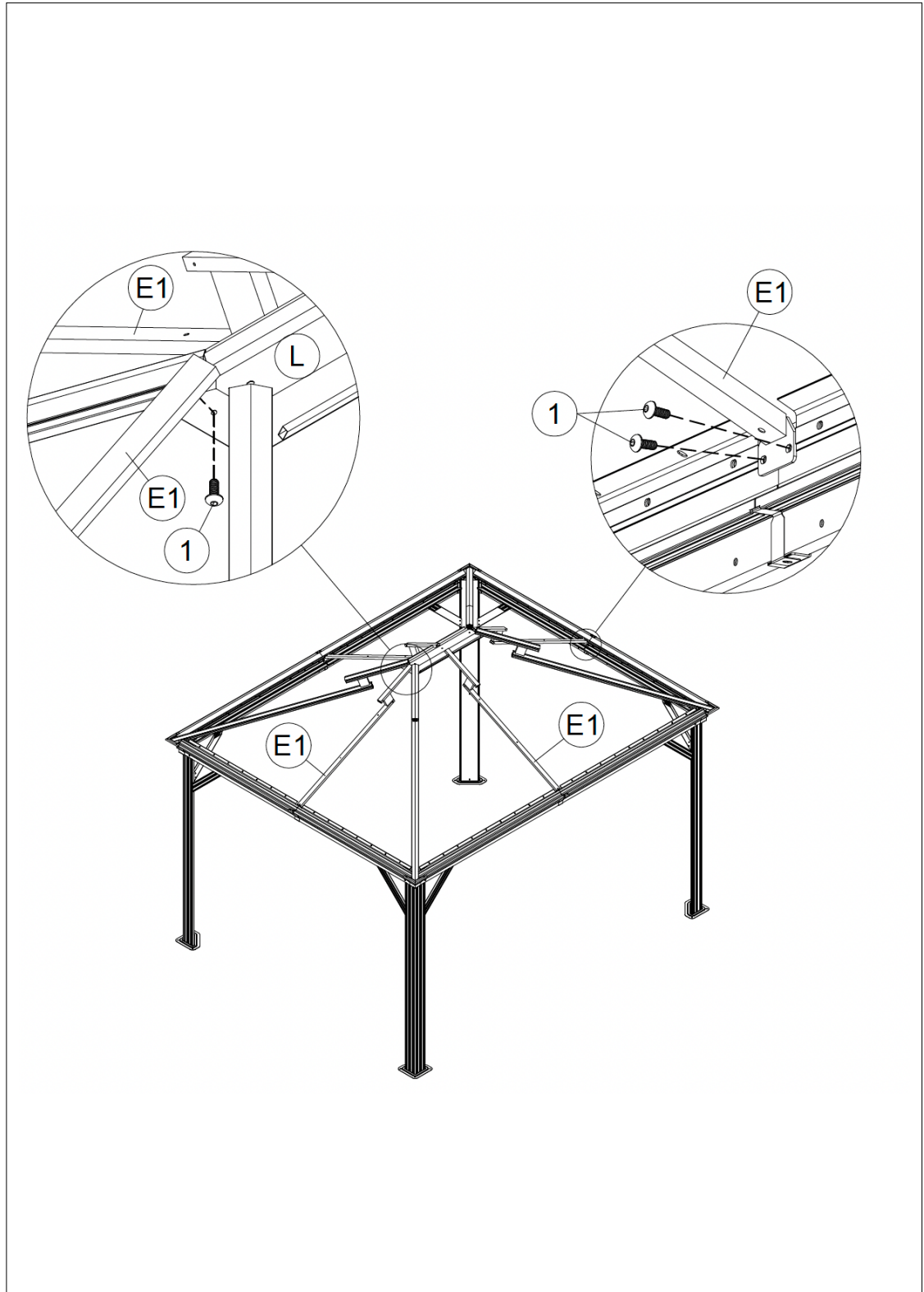
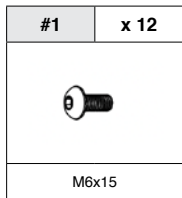
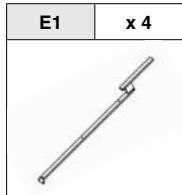

ASSEMBLAGE / ASSEMBLY

Étape / Step 9

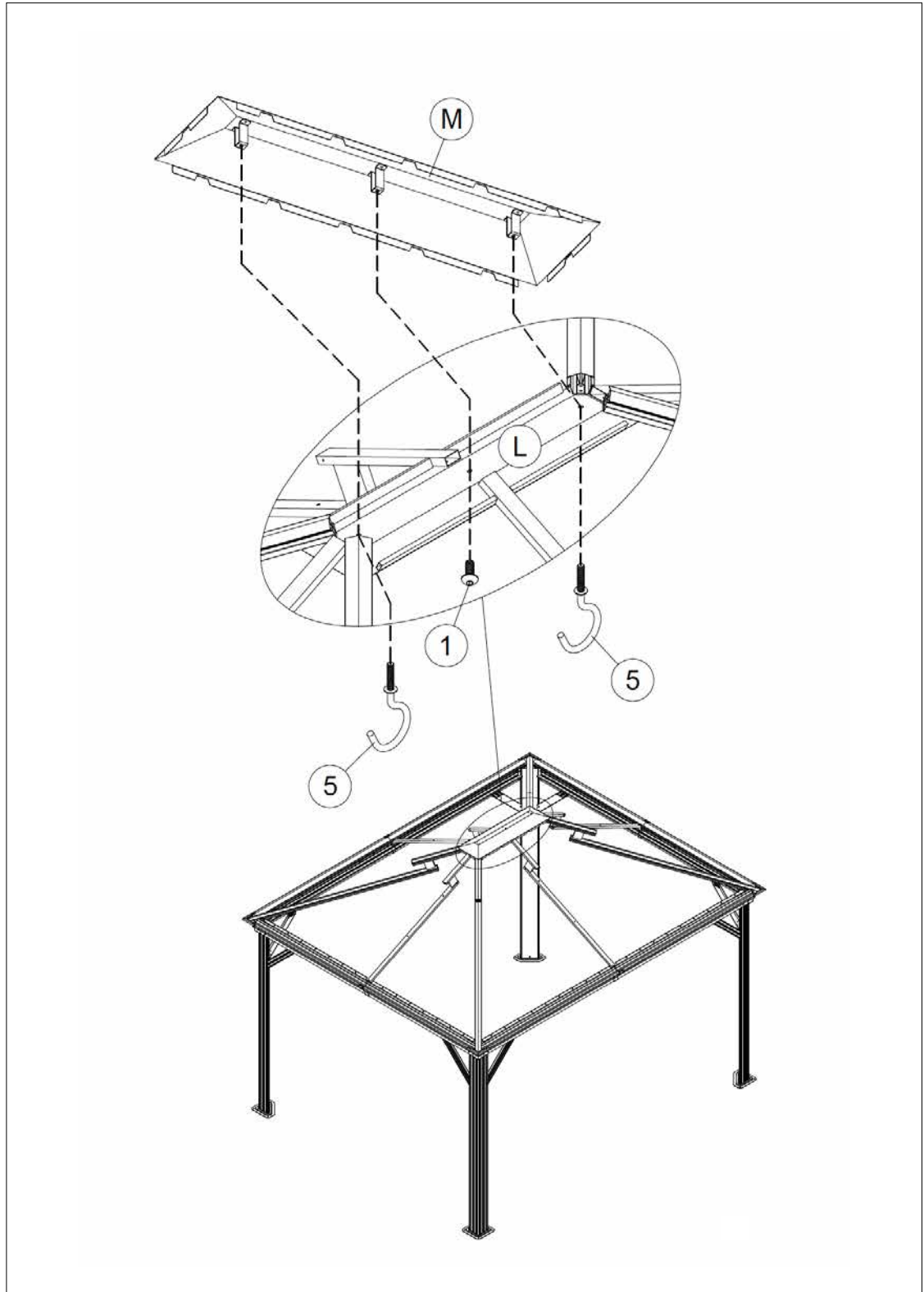
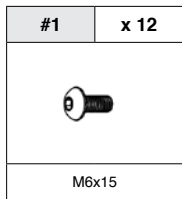
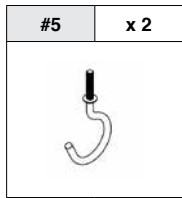
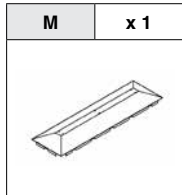

ASSEMBLAGE / ASSEMBLY

Étape / Step 10

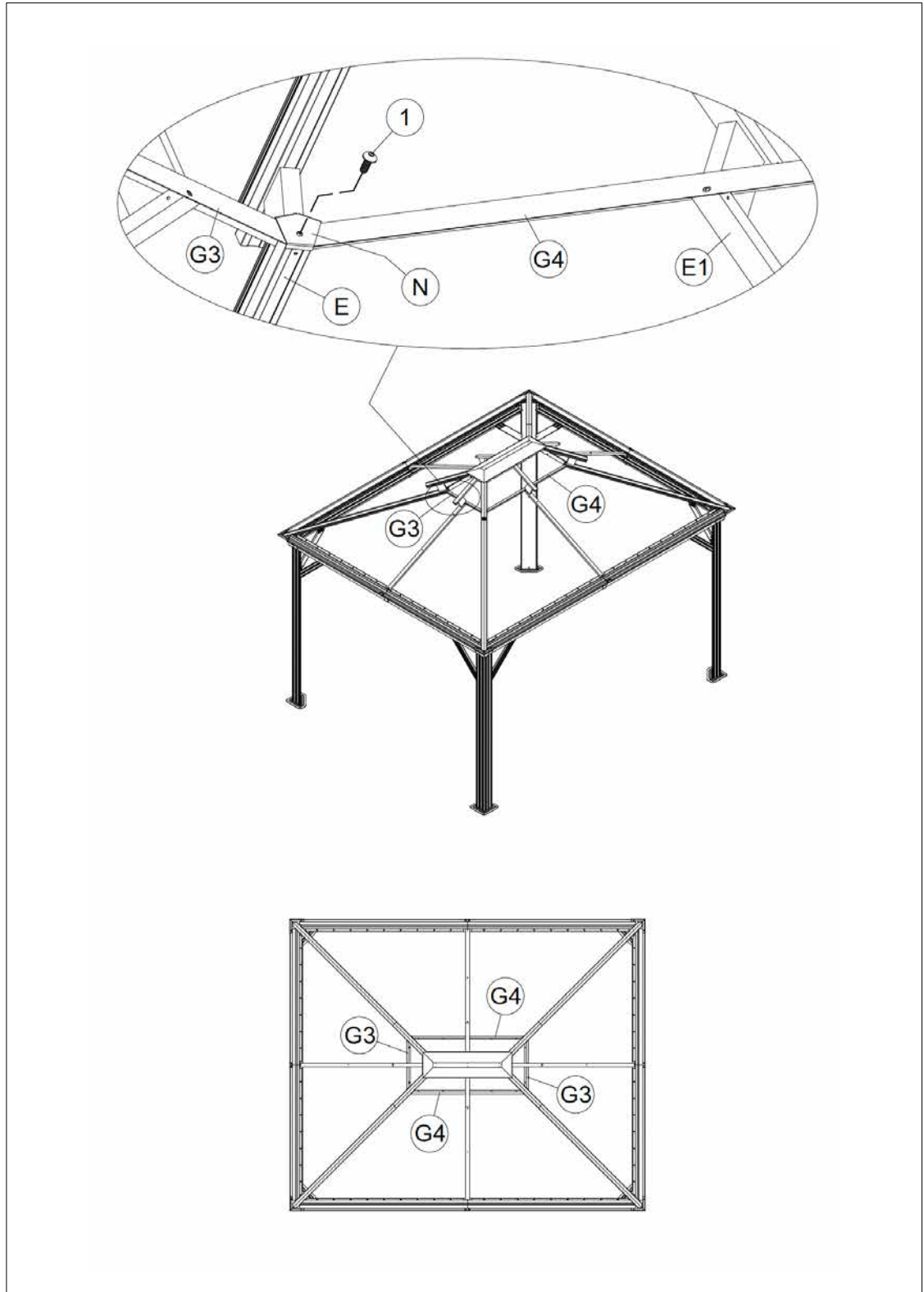
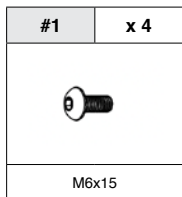
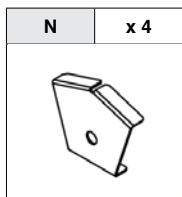
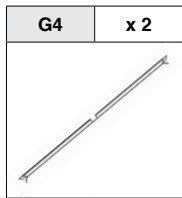
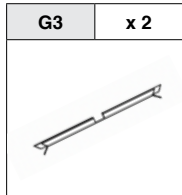

ASSEMBLAGE / ASSEMBLY

Étape / Step 11

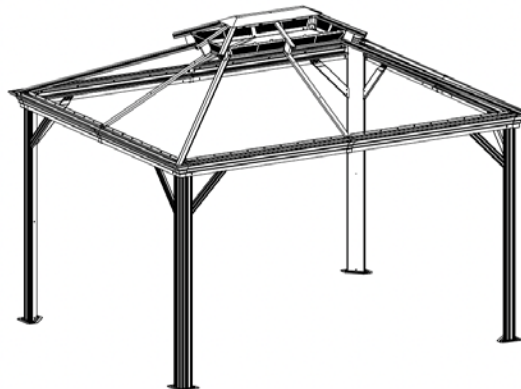
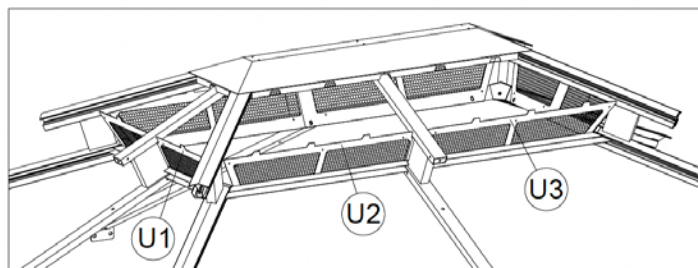
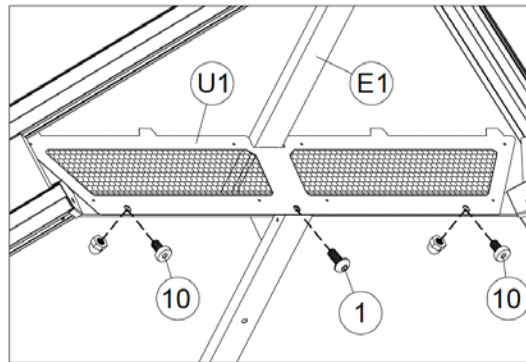
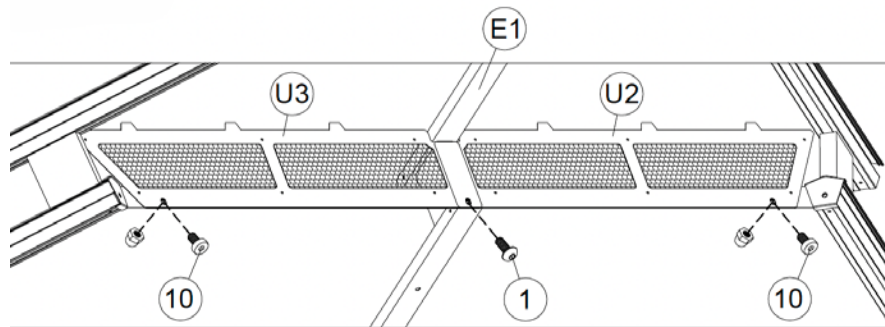
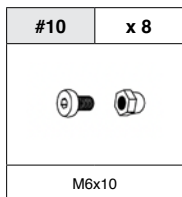
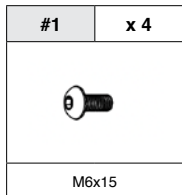
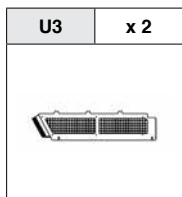
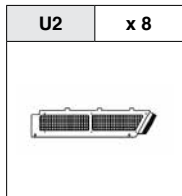
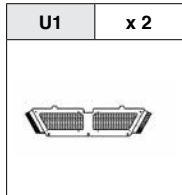

ASSEMBLAGE / ASSEMBLY

Étape / Step 12

| | | |
|-----------|-------------|--|
| Q | x 2 | |
| | | |
| Q1 | x 2 | |
| | | |
| Q2 | x 2 | |
| | | |
| R1 | x 2 | |
| | | |
| R2 | x 2 | |
| | | |
| R3 | x 2 | |
| | | |
| R4 | x 2 | |
| | | |
| S | x 2 | |
| | | |
| S1 | x 2 | |
| | | |
| S2 | x 2 | |
| | | |
| Z | x 56 | |
| Z1 | x 16 | |

ASSEMBLAGE / ASSEMBLY

Étape / Step 13

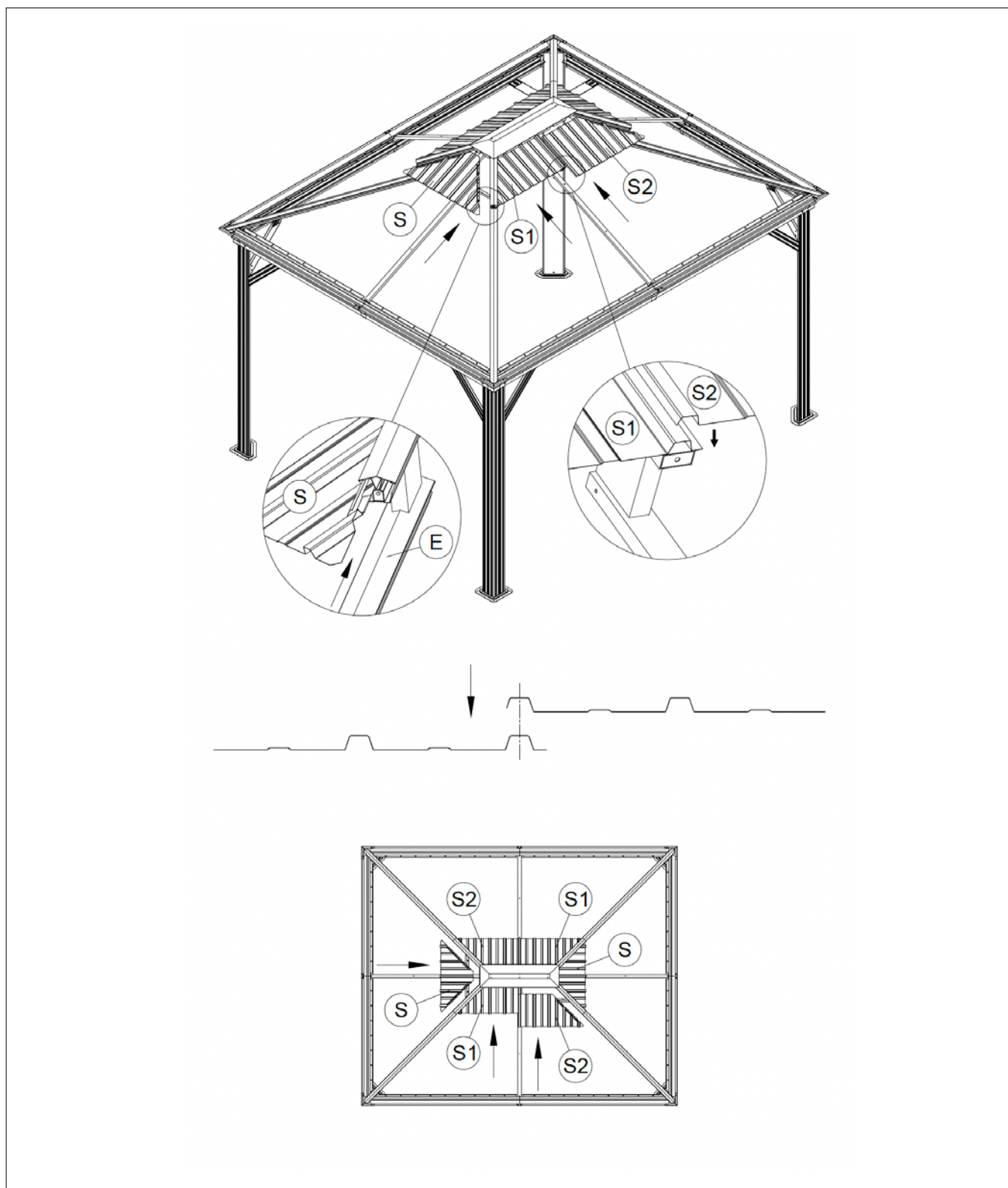

ASSEMBLAGE / ASSEMBLY

Étape / Step 14

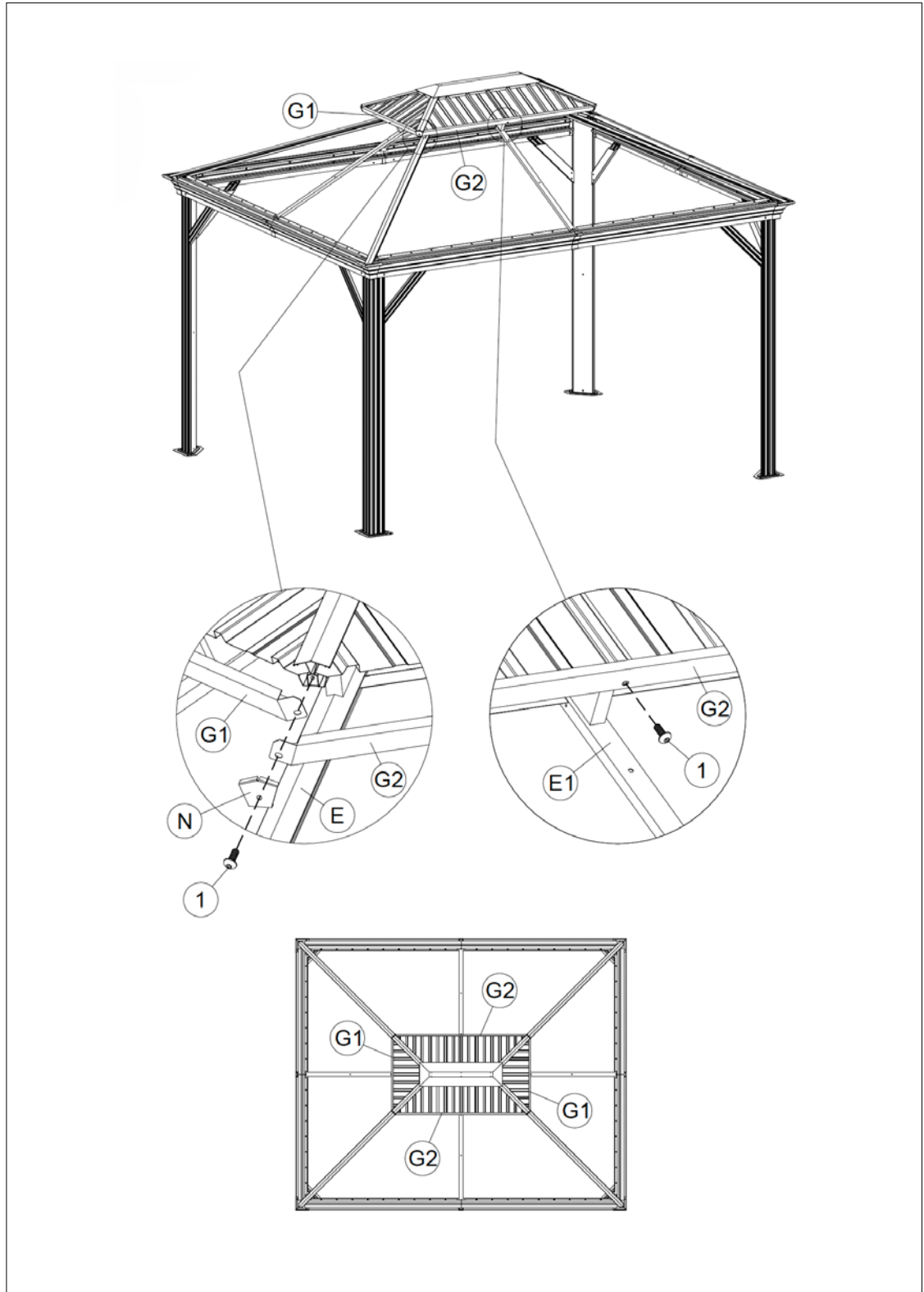
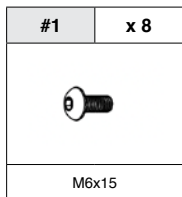
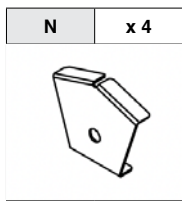
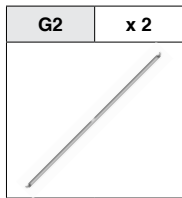
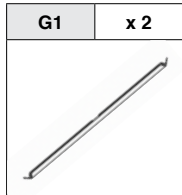

ASSEMBLAGE / ASSEMBLY

Étape / Step 15

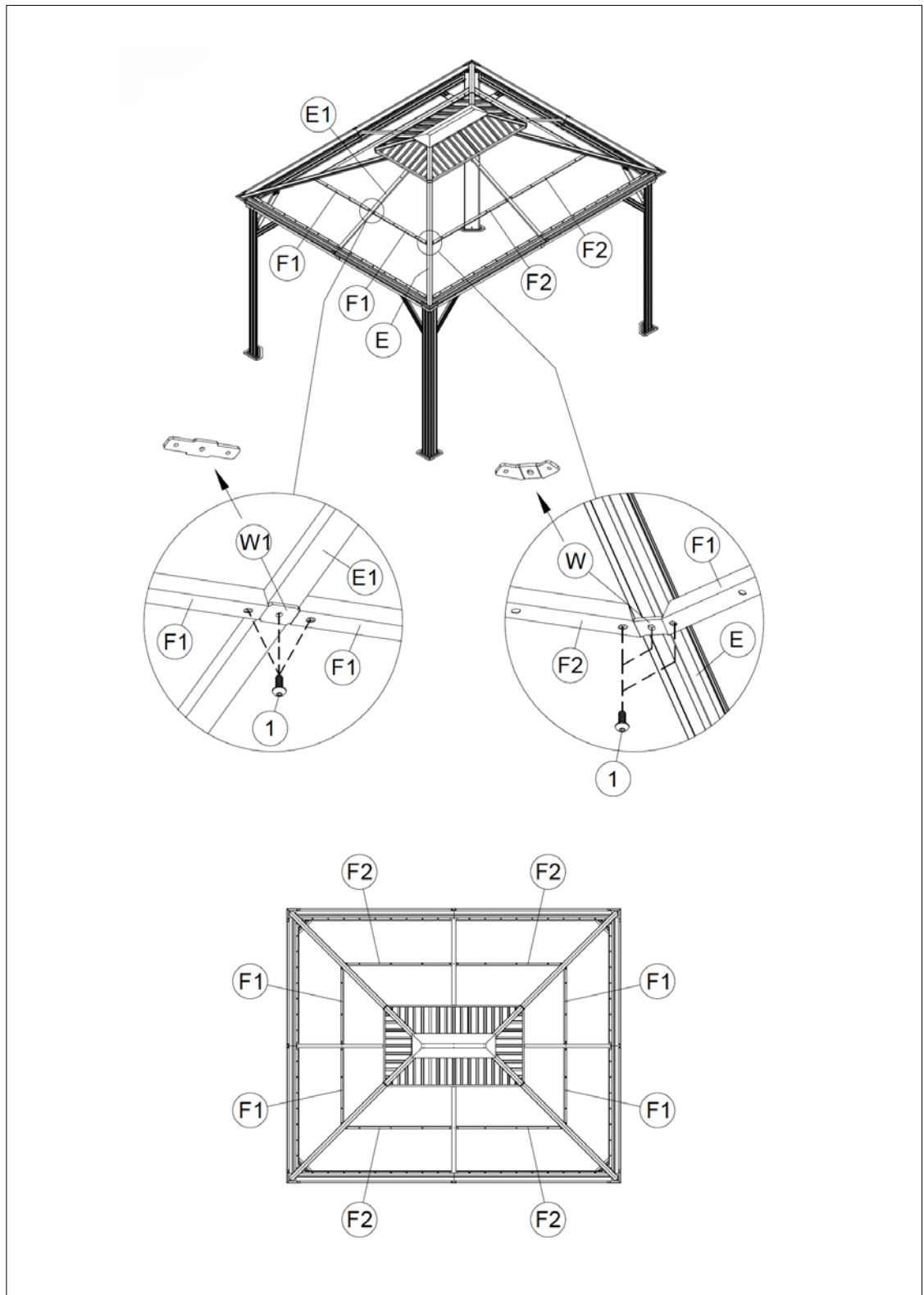
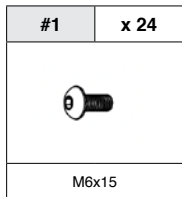
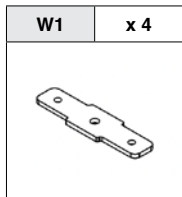
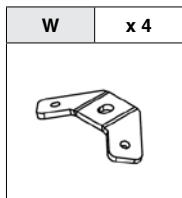
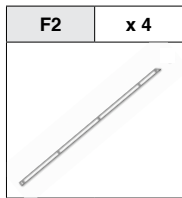
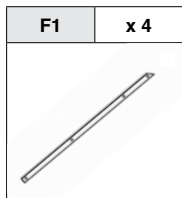

ASSEMBLAGE / ASSEMBLY

Étape / Step 16

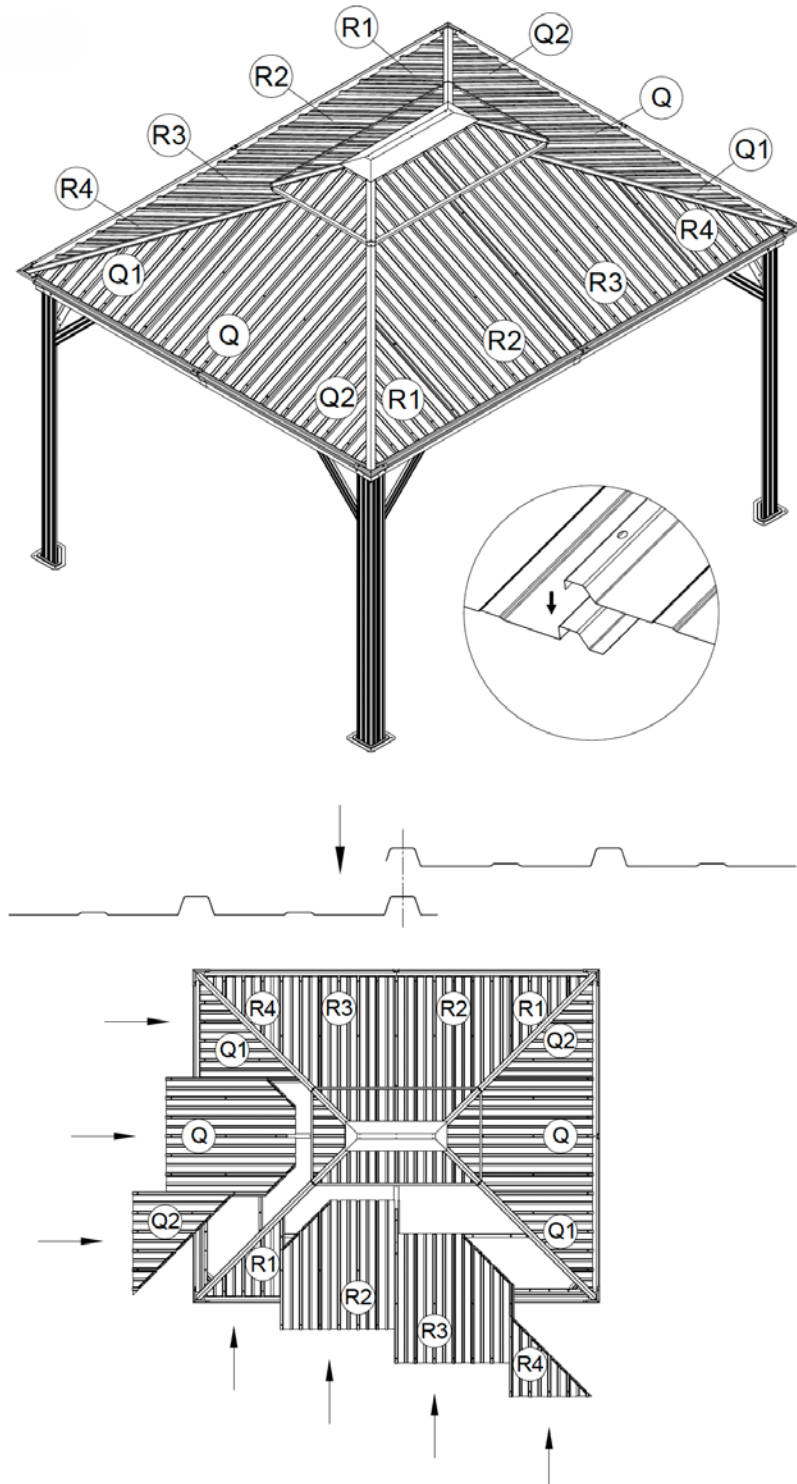

ASSEMBLAGE / ASSEMBLY

Étape / Step 17

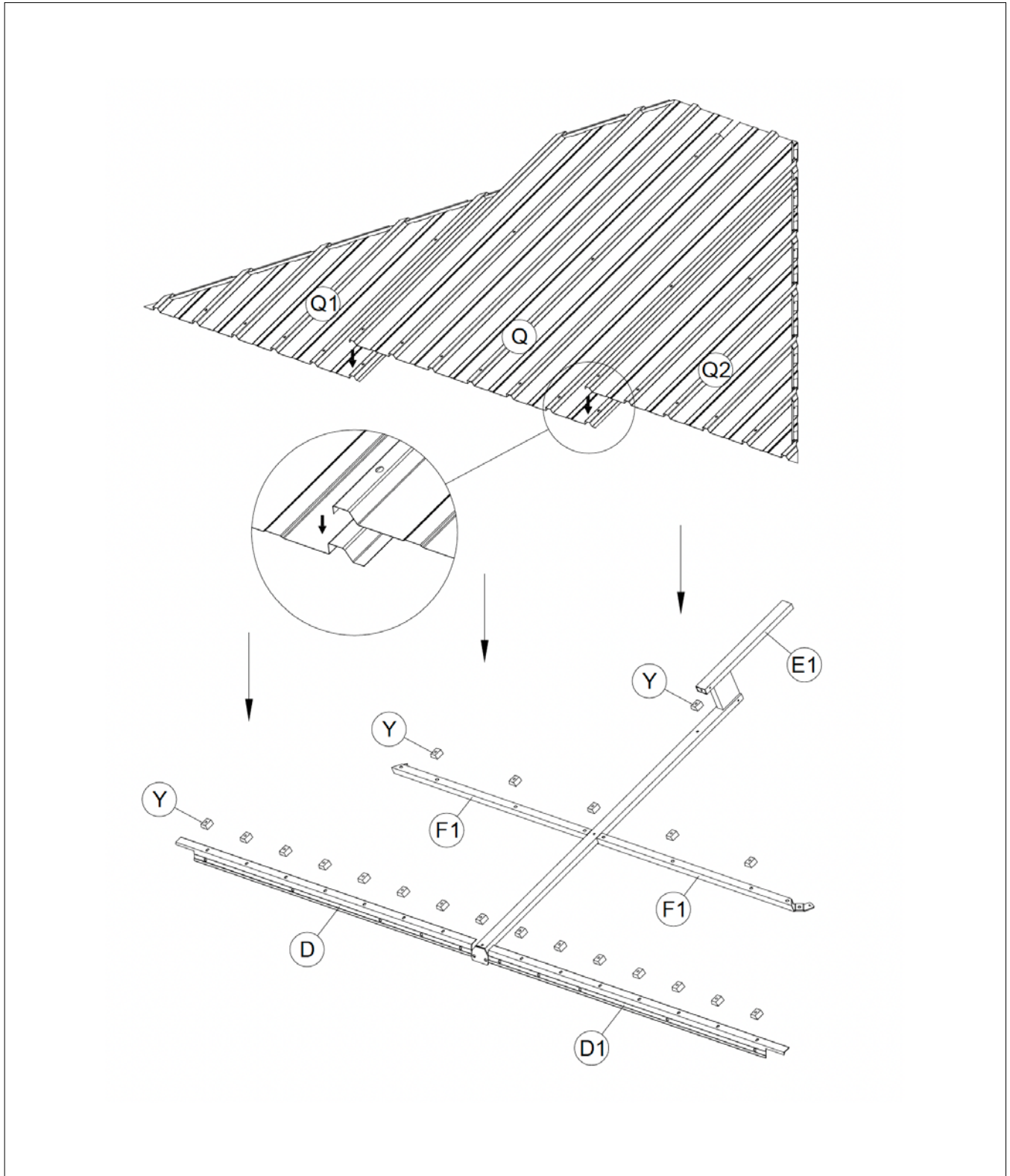

ASSEMBLAGE / ASSEMBLY

Étape / Step 18

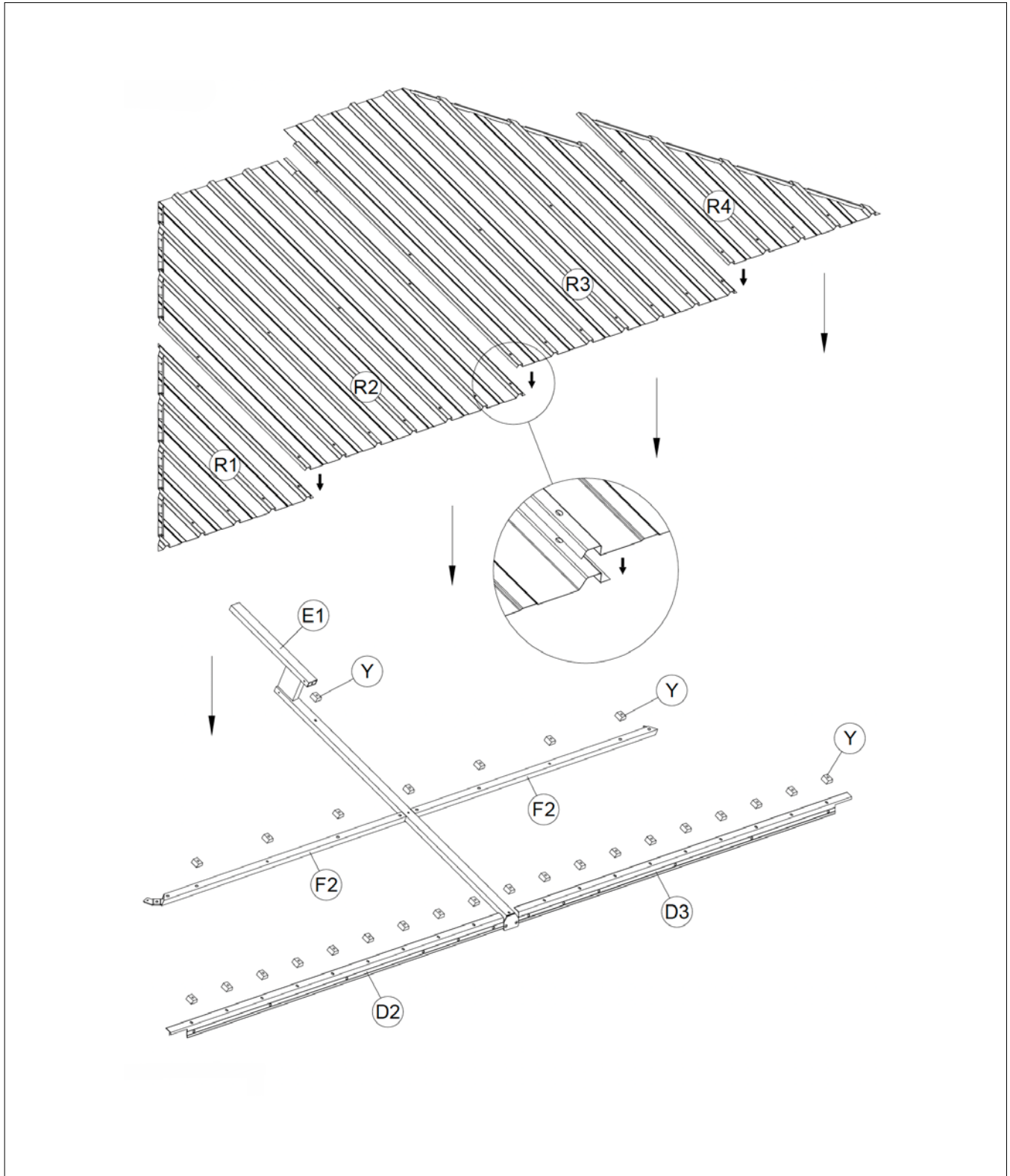

ASSEMBLAGE / ASSEMBLY

Étape / Step 19

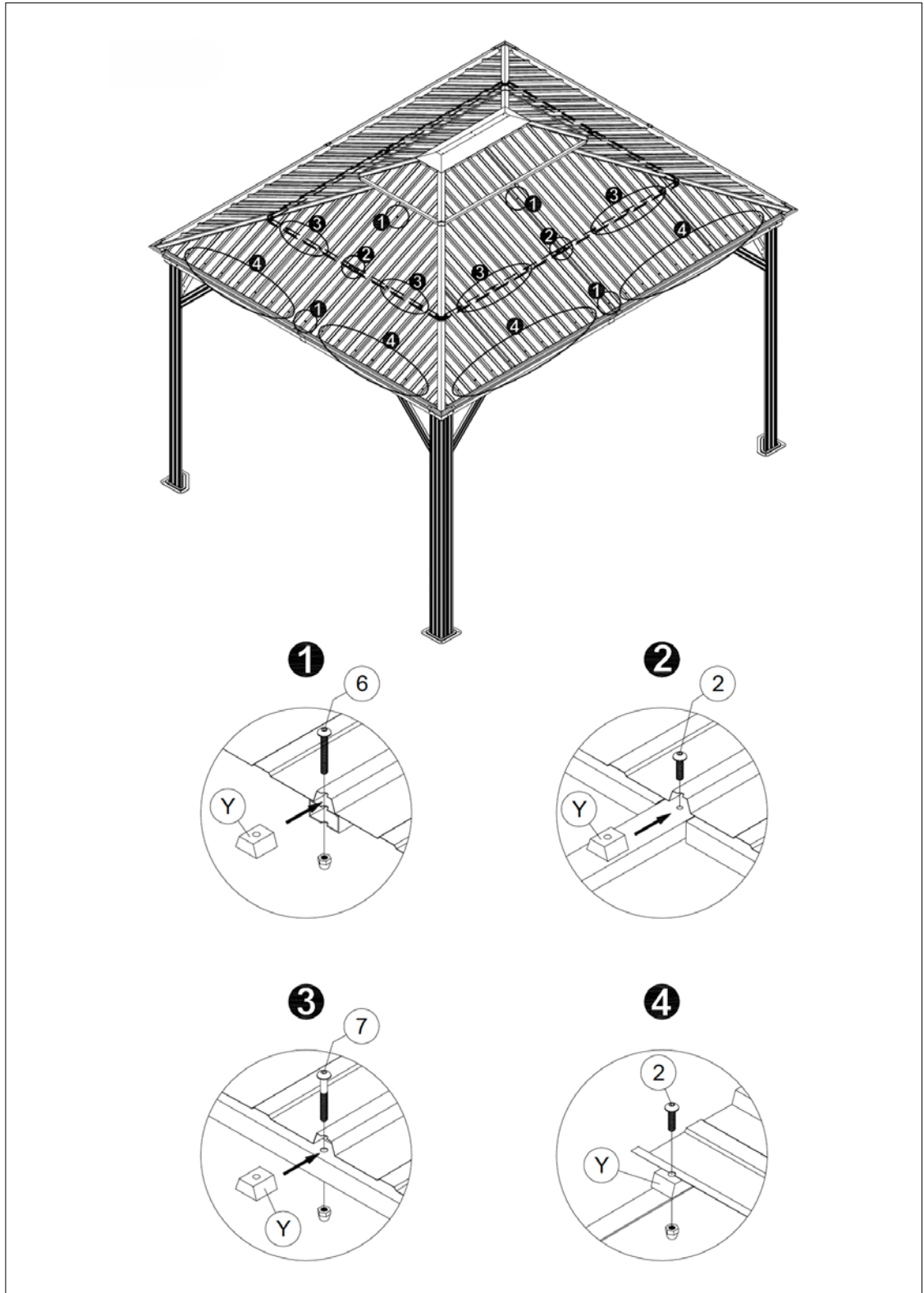
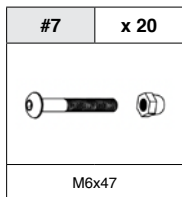
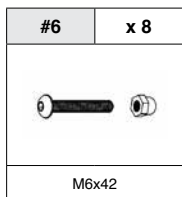
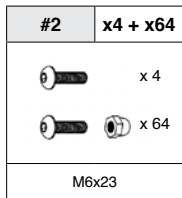
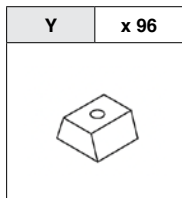

ASSEMBLAGE / ASSEMBLY

Étape / Step 20

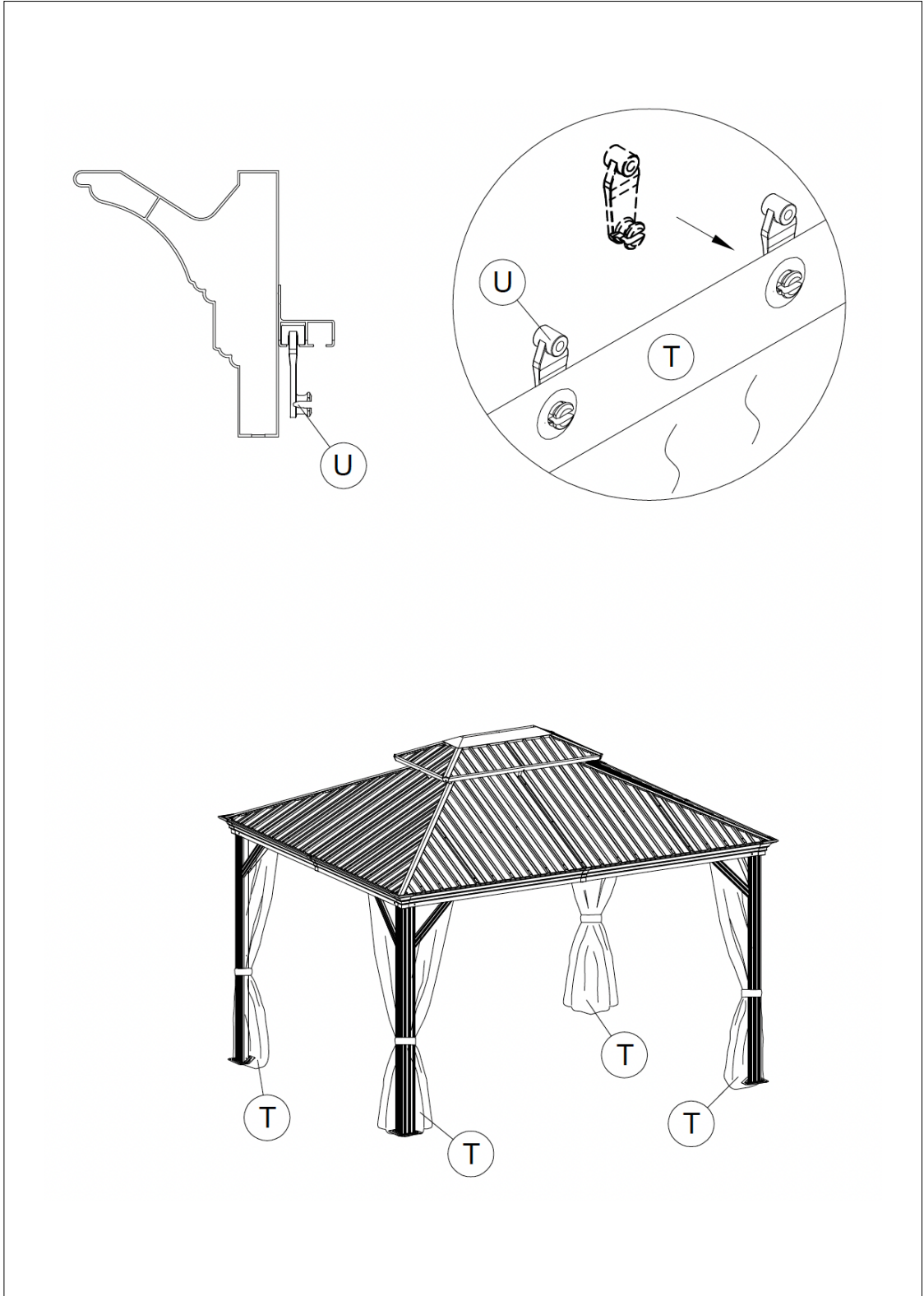
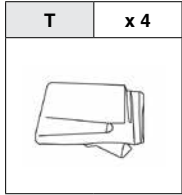

ASSEMBLAGE / ASSEMBLY

Étape / Step 21

