

2026

Plunge Pool Operator's Guide

This manual includes
Installation, Operation, Maintenance and Safety Information



English Manual

⚠️ NOTE

SAVE THESE IMPORTANT SAFETY INSTRUCTIONS

This manual contains important safety, operating, and installation instructions - read before installing or operating plunge pool.

Welcome New Plunge pool Owners

Dear Plunge Pool Owner:

Congratulations on your purchase of a new plunge pool. You now possess the ultimate passport to tranquility - a daily vacation at home, ready and waiting for you in your own backyard!

We want you to enjoy your plunge pool. Many hours of research have gone into the design of your plunge pool to ensure the ultimate in hydrotherapy and relaxation. Only the highest quality components have been used to ensure years of trouble free operation. Your comfort and enjoyment have been designed into your plunge pool from the start.

Please take the time to read through this Operator's Guide. In it you will find guidelines on caring for your plunge pool, a complete explanation of the controls, safety instructions, a trouble-shooting section, and lots more.

Thank you for your business and your confidence in our company. We look forward to serving you!



Scan the qr code if you need to replace the owner's manual.

Your Dealers Information

Table of Contents

SAFETY INSTRUCTIONS	4-11	FILTER LOCATIONS/ MAINTENANCE	23-24	PLUNGE POOL WATER MAINTENANCE	30-32
WARNING TAGS		SET-UP AND DELIVERY		Water Testing	
Important Safety Instructions		Surface & Pad Requirements		Balance	
Read and Follow		Balcony & Deck Requirements			
BASIC INFORMATION	12	Access Clearance			
		Outdoor Installation			
		Indoor Installation			
NORTH AMERICAN ELECTRICAL REQUIREMENTS	13-15	Electrical Requirements			
		Priming Pump			
		Dual Filters			
EUROPEAN ELECTRICAL REQUIREMENTS	16-17	Cleaning and Replacing Filter			
		Cartridge Enclosed Style			
		Open Style			
PLUNGE POOL SCHEMATICS	18-19	GENERAL PLUNGE POOL MAINTENANCE	25	WINTERIZING / SPRING START UP YOUR PLUNGE POOL	33-34
		Suction Cover		How to Winterize	
GUIDELINES	20-21	Protect Your Cover		How to Start-up	
		Protect Your Surface			
				TOPSIDE CONTROLS	35
PRE OPERATION INSTRUCTIONS	22			GENERAL FUNCTIONS	36-37
				GENERAL DIAGNOSTIC MESSAGE	38-39
		PLUNGE POOL TERMINOLOGY	26-29	TROUBLESHOOTING	40-41
		Jets		WARRANTY SUMMARY	42-43
		Equipment Access Panel		Disclaimer	
		Access Panels		Safety Sign	
		Draining your Plunge Pool		Plunge pool Manufacturer	
		Weir Gate			
		Plunge Pool Light			
		Plunge Pool Heater			
		Gate Valves			
		Main Pump			
		Cleaning Your Plunge Pool Water			
		Filling Plunge Pool with Water			

This Operator's Guide utilizes the following symbols to emphasize particular information.



The Safety Alert Symbol indicates a potential hazard

⚠ WARNING

⚠ CAUTION

⚠ NOTE

SAFETY DO'S AND DONT'S

DO

- DO read all operating instructions.
- DO read, understand and follow all safety, danger and warning instructions before use.
- DO test water temperature with your hand before entering.
- DO check regularly that the suction covers are properly secured and have not expired.
- DO keep the cover down when the plunge pool remains unused.

The plunge pool manufacturer shall provide instruction that the plunge pool shall be secured to protect against unauthorized access per local codes.

DO NOT

- DO NOT block or sit on the filter recess area.
- DO NOT allow horseplay or unsupervised use of your plunge pool.
- DO NOT allow anyone to tamper or play with any of the safety or suction fittings of your plunge pool.

WARNING / CAUTION TAGS DIAGRAM



WARNING / CAUTION TAGS DIAGRAM

ATTENTION

IMPROPER WIRING WILL VOID WARRANTY

WIRING REQUIREMENTS:

- 2-Hots, 1-Neutral, 1-Isolated Ground
- 4 Wire #8 AWG minimum 75°C copper conductor

Note: The white neutral wire from the back of the GFCI MUST be connected to an incoming line neutral. The internal mechanism of the GFCI requires this neutral connection. The GFCI will not work without it.

(WHITE WIRE TO THE SPA)

SPA CONTROL BOX

Y-SERIES

Refer to Manual

02262025 GFCI TAG

ATTENTION

UNE CONNECTION INADEQUATE ANNULERA LA GARANTIE

CABLAGE REQUIS:

- 2-Lignes, 1 Neutre et 1 Mise à Terre (Ground) isolé
- 4 Fils #8 AWG en cuivre min. 75°C est requis lorsque

Note: Le fil de neutre (blanc) provenant de l'arrière du disjoncteur doit être connecté à un fil de neutre entrant. Le mécanisme interne du disjoncteur a besoin de cette connexion. Le disjoncteur ne fonctionnera pas sans celle-ci.

(LIGNE BLANCHE VERS LE SPA)

BOITIER DU SPA

Y-SERIES

Se référer au manuel

02262025 GFCI TAG

WARNING

DURING PREGNANCY, SOAKING IN HOT WATER MAY CAUSE DAMAGE TO THE FETUS. LIMIT USE TO 10 MINUTES AT A TIME.

PREVENT DROWNING

SPA HEAT SPEEDS UP THE EFFECTS OF ALCOHOL, DRUGS OR MEDICINE AND CAN CAUSE UNCONSCIOUSNESS. IMMEDIATELY LEAVE SPA IF UNCOMFORTABLE OR SLEEPY.

PREVENT CHILD DROWNING

WATER ATTRACTS CHILDREN. ALWAYS ATTACH A SPA COVER AFTER EACH USE.

AVERTISSEMENT!

PENDANT LA GROSSESSE, SE Baigner dans une eau chaude peut nuire à la santé du fœtus. Limitez le temps de baignade à 10 minutes.

RISQUE DE NOYADE

LA CHALEUR DU SPA ACCÉLÈRE LES EFFETS DE L'ALCOOL, DE DROGUES OU DE CERTAINS MÉDICAMENTS, ET PEUT PROVOQUER UNE PERTE DE CONNAISSANCE. SORTIR DU SPA IMMÉDIATEMENT SI VOUS VOUS SENTEZ MAL OU ÉTOURDI.

RISQUE DE NOYADE POUR LES ENFANTS

L'EAU ATTIRE LES ENFANTS. PENSEZ TOUJOURS À ATTACHER LA COUVERTURE DE VOTRE SPA APRÈS CHAQUE UTILISATION.

02262025 - VNT

ATTENTION/ATTENTIE/ATTENZIONE

INSTALL FILTERS BEFORE FILLING SPA!:

1. Remove filters from plastic bag.
2. Carefully thread filters into fittings
3. DO NOT OVERTIGHTEN. A snug fit is all that is required.

AVANT DE METTRE DE L'EAU:

1. Enlever le plastique sur les cartouches de filtration.
2. Visser les cartouches dans l'emplacement.
3. NE PAS SERRER TROP FORT, il suffit d'ajuster les cartouches.

INSTALE FILTROS ANTES DE LLENAR EL SPA!:

1. Saque los filtros de la bolsa de plástico.
2. Con cuidado, instale los filtros en sus emplazamientos.
3. NO LOS APRETE DEMASIADO. Basta con ajustarlos.

02262025 - FN

CAUTION/PAS OP/ATTENZIONE

Please avoid using any spa chemicals that contain Tri Chlorine. Tri Chlorine based spa chemicals have been found to react adversely with the materials used to produce these components. We recommend the use of Chlorine and Bromine based products only. Any structural and/or cosmetic jet failure linked to the use of Hydrogen Peroxide based products will not be covered under your warranty. Please consult your Dealer for approved chemical options.

Merci de ne pas utiliser de produits chimiques pour spas contenant du trichlore. Les produits pour spas à base de Peroxide hydrogène produisent une réaction chimique qui va détériorer les jets. Nous recommandons l'utilisation de produits à base de Chlore ou de Brome seulement. Aucun jet détérioré avec du trichlore ne pourra être couvert par la garantie. Merci de consulter votre revendeur pour obtenir des conseils sur les produits chimiques compatibles.

Por favor, no utilice ningún producto químico que contenga agua oxigenada. Se ha comprobado que este tipo de productos químicos reaccionan negativamente con los materiales utilizados para producir estos componentes. Recomendamos el uso de productos exclusivamente basados en cloro y bromo. Cualquier avería o fallo de los jets relacionada con el uso de productos basados en agua oxigenada no quedará cubierta por la garantía. Por favor, consulte con su distribuidor para obtener información sobre los productos químicos compatibles.

02262025 CJT

WARNING

REDUCE THE RISK OF ELECTROCUTION

1. Never place an electric appliance within 5 feet of spa.

REDUCE THE RISK OF CHILD DROWNING

1. Supervise children at all times.
2. Attach spa cover after each use.

REDUCE THE RISK OF OVERHEATING

1. Check with a doctor before use if pregnant, diabetic, in poor health, or under medical care.
2. Exit immediately if uncomfortable, dizzy, or sleepy. Spa heat can cause hyperthermia and unconsciousness.
3. Spa heat in conjunction with alcohol, drugs or medication can cause unconsciousness.

WHEN PREGNANT Soaking in hot water for long periods can harm your fetus. Measure water temperature before entering.

1. Do not enter spa if water is hotter than 104° F (40° C).
2. Do not stay in spa for longer than 10 minutes.

02262025 WS

Information for Permanent Installation

CONFORMS TO: UL STD 1563
CERTIFIED TO: CSA STD C22.2 NO. 218.1

MODEL NO. []
SERIAL NO. []
DATE OF MAN. []

Electrical Ratings

Pack: YE	Pack: YT
VOLTS: 240	VOLTS: 240
HERTZ: 60	HERTZ: 60
AMP: 40 or 48	AMP: 40 or 48
PHASE: 1	PHASE: 1

FLOW RATE: 190 GPM

Attached GFCI cord is removable for Permanent installation

Must be GFCI protected 680.44 (NEC)
Must be at or above grade to meet "Self Contained Guidelines"

02262025 ET

DS DYNASTY SPAS Dynasty Spas • Athens • Tennessee • USA

L'information pour l'installation permanente

CONFORME À: UL DST 1563
CERTIFIÉ À: NO. 218.1 DE CSA DST C22.

NO. DE MODÈLE: []
NO. DE SÉRIE: []
DATE DE FABRICATION: []

Caractéristiques électriques

Contrôleur: YE	Contrôleur: YT
VOLTS: 240	VOLTS: 240
FRÉQUENCE: 60	FRÉQUENCE: 60
AMPÉRAGE: 40 ou 48	AMPÉRAGE: 40 ou 48
PHASE: 1	PHASE: 1

DÉBIT: 190 GPM

Contrôleur: YE

VOLTAGE: 120
FRÉQUENCE: 60
AMPÉRAGE: 15 ou 20
PHASE: 1

La disjoncteur de Fuite à la terre est démontable pour l'installation permanente

Doit être protégé par un disjoncteur différentiel (GFCI) 680.44 (NEC). Doit être au niveau du sol ou au-dessus pour respecter les "Directives pour l'autonomie"

02262025 ET

DS DYNASTY SPAS Dynasty Spas • Athens • Tennessee • USA

AVERTISSEMENT

POUR RÉDUIRE LES RISQUES D'ÉLECTROCUTION

1. Ne jamais placé un appareil électrique à moins de 5 pieds du spas.

POUR RÉDUIRE LES RISQUES DE NOYADE CHEZ LES ENFANTS.

1. Surveiller les enfants en tout temps
2. Attacher le couvert du spa après usage.

POUR RÉDUIRE LES RISQUES DE SURCHAUFFE

1. Si vous êtes enceinte, diabétique, en mauvaise santé ou sous suivi médical, consulter votre docteur avant l'utilisation.
2. Sortir immédiatement du spa si vous êtes inconfortable, ressentez un malaise ou vous endormez, la chaleur du spa peut causer de l'hyperthermie et des pertes de consciences.
3. La chaleur du spa, la consommation de drogues et d'alcool ou de médicaments peut causer des pertes de conscience.

LORSQU'ENCEINTE LA BAINNADE DANS L'EAU CHAUDE PENDANT UNE LONGUE PÉRIODE PEUT ÊTRE NUISIBLE AU FETUS. TOUJOURS VÉRIFIER LA TEMPÉRATURE AVANT D'ENTRER.

1. Ne pas utiliser le spa si la température est plus élevée que 104 F (40c).
2. Ne pas rester dans le spa plus de 10 minutes.

02262025 WS

SAFETY INSTRUCTIONS

SAVE THESE INSTRUCTIONS

Included with your new plunge pool is a safety sign. The sign is for you and your guest's protection and is suitable for outdoor use in wet locations. The sign should be placed in a location visible to all users of the plunge pool.

Please take time to point out the physical location of the safety sign and the importance of the safety precautions displayed on the safe-

ty sign to all of your guests. Remember, your safety and the safety of anyone who enjoys the use of your plunge pool is our utmost concern.

The sign should be mounted with screws or another type of permanent fastener. Additional or replacement signs can be obtained from your dealer or direct from our factory.

NO CLIMBING OR WALKING ON TOP RAIL

! DANGER



**SHALLOW WATER
NO DIVING - NO JUMPING**



**DIVING OR JUMPING MAY
CAUSE DEATH, PARALYSIS OR
PERMANENT INJURY**

**FAILURE TO FOLLOW THESE RULES
MAY CAUSE DEATH, PARALYSIS OR PERMANENT INJURY**

HOW TO PREVENT DIVING/JUMPING ACCIDENTS

- This is a non-diving pool/swim spa system.
- Do not dive or jump into this pool/swim spa under any circumstances.
- Do not utilize sliding equipment with this pool/swim spa system.
- Do not utilize diving equipment with this pool/swim spa system.

HOW TO PREVENT CHILD DROWNING ACCIDENTS

- Children must be constantly and closely supervised when using the pool/swim spa system.
- Children must not be allowed in the pool/swim spa system area without an adult being present.
- The pool/swim spa system cover must be closed and locked when the pool/swim spa system is not being used.
- Portable ladders must be removed when not in use.
- Limited access ladders must be removed or latched in the raised position when not in use.

HOW TO PREVENT OTHER ACCIDENTS

- Do not swim alone.
- Do not use the pool/swim spa system if you taken drugs or consumed alcohol.
- Non-swimmers must stay in the shallow end of the pool/swim spa system.

For additional Information please read the safety and usage information supplied in the Installer/Owner envelope.

EMERGENCY PHONE NUMBER

02262025 DS 11X17

NE PAS GRIMPER NI MARCHER SUR LA MARGELLE

! DANGER



**EAU PEU PROFONDE
NE PAS PLONGER - NE PAS SAUTER**



**LES PLONGEONS ET LES SAUTS
POURRAIENT CAUSER LA MORT,
LA PARALYSIE OU DES BLESSURES PERMANENTES**

**LE NON-RESPECT DE CES RÈGLES POURRAIT CAUSER
LA MORT, LA PARALYSIE OU DES BLESSURES PERMANENTES**

COMMENT PRÉVENIR LES ACCIDENTS

- Il est interdit de plonger dans cette piscine / ce spa.
- En toutes circonstances, ne pas plonger dans cette piscine / ce spa.
- Ne pas utiliser de glissade avec cette piscine / ce spa.
- Ne pas utiliser d'équipement de plongeur avec cette piscine / ce spa.

COMMENT PRÉVENIR LES NOYADES D'ENFANTS

- Les enfants doivent être surveillés et supervisés en tout temps lorsqu'ils utilisent la piscine / le spa.
- Les enfants ne doivent pas avoir accès à la piscine / au spa sans la présence d'un adulte.
- La piscine / le spa doit être fermé(e), inaccessible et / ou verrouillé(e) lorsque personne ne le / les utilise.
- Les marches et échelles escamotables doivent être retirées lorsque personne n'utilise la piscine / le spa.
- Les échelles / marches à accès contrôlé doivent être enlevées ou fixées de manière à demeurer inaccessibles lorsque personne n'utilise la piscine / le spa.

COMMENT PRÉVENIR LES AUTRES ACCIDENTS

- Ne jamais se baigner seul(e).
- Ne pas utiliser la piscine / le spa sous l'effet de l'alcool ou des drogues.
- Les gens qui ne savent pas nager doivent demeurer dans la partie peu profonde de la piscine / du spa.

Pour plus d'information, veuillez lire les renseignements sur l'utilisation et sur la sécurité qui ont été fournis dans la trousse d'installation / le guide du propriétaire.

TÉLÉPHONE D'URGENCE

02262025 DS 11X17

IMPORTANT SAFETY INSTRUCTIONS

SAVE THESE INSTRUCTIONS

WARNING: Pregnant or possibly pregnant women should consult a physician before using a plunge pool or hot tub.

WARNING: Water temperature in excess of 104°F (40° C) may be injurious to your health.

WARNING: Before entering the plunge pool or hot tub measure the water temperature with an accurate thermometer.

WARNING: Do not use a plunge pool or hot tub immediately following strenuous exercise.

WARNING: Prolonged immersion in a plunge pool or hot tub may be injurious to your health.

WARNING: Do not permit electric appliances (such as a light, telephone, radio, or television) within 1.5 M of this plunge pool or hot tub.

CAUTION: Maintain water chemistry in accordance with manufacturer's instruction.

The spa or plunge pool water shall be tested and treated in accordance with local codes.

NOTE: For Pool and Hot Tub Water Sanitation, see Uniform Swimming Pool, Spa and Hot Tub Code, Chapter 5 - Water Quality.

WARNING!

When installing and using this electrical equipment, basic safety precautions should be followed, including the following:

IMPORTANT SAFETY INSTRUCTIONS

READ AND FOLLOW ALL INSTRUCTIONS

1. WARNING - To reduce the risk of injury, do not permit children to use this product unless they are closely supervised at all times.

2. DANGER-RISK OF CHILD DROWNING. Extreme caution must be exercised to prevent unauthorized access by children. To avoid accidents, ensure that children cannot use the plunge pool unless they are supervised at all times.

NOTE: A wire connector is provided on this unit to connect a wire of a minimum No. 4 AWG minimum 75°C copper conductor between this unit and any metal equipment, metal enclosures of electrical equipment, metal water pipe, or conduct within 5 feet (1.52 m) of the unit.

3. DANGER - RISK OF ELECTRIC SHOCK. Install plunge pool at least five (5) feet (1.52 m) from all metal surfaces. A plunge pool may be installed within five (5) feet (1.52 m) of metal surfaces if, in accordance with the National Electrical Code / IEC, each metal surface is permanently connected by a minimum No. 4 AWG (6. mm) minimum 75°C copper conductor attached to the wire connector on the terminal box. A grounding lug is provided for this purpose.

4. DANGER - RISK OF INJURY. The suction fittings in this plunge pool are sized to match the specific water flow created by the pump. Should the need arise to replace the suction fittings or the pump, be sure that the flow rates are compatible.

NOTE: Never operate the plunge pool if the suction fittings are broken or missing. Never replace a suction fitting with one rated less than the flow rate marked on the original suction fitting.

5. DANGER - Failure to keep suction outlet components clear of debris, such as leaves, dirt, hair, paper and other material, can result in an increased potential for suction entrapment. Suction outlet components have a finite life. The cover/grate should be inspected frequently and replace at least every seven years, or if found to be damaged, broken,

cracked, missing, or not securely attached. If the fitting is missing or broken, replace with a fitting of equivalent rating or higher. Use of a lower rated suction fitting could result in entrapment of the body which could result in serious injury including drowning. Do not use or operate plunge pool/hot tub if this suction fitting is missing, broken or not secured per instructions. The suction fitting is intended to prevent entrapment of the body. Use of the plunge pool/hot tub with a missing, broken or improperly secured suction great may result in serious injury including drowning. When the plunge pool or hot tub is in operation, suction at this fitting. Users of the plunge pool or hot tub must not to come in contact with this fitting in such a way a to block its orifice. If a user of the plunge pool or hot tub blocks this fitting with his/her body, serious personal injury or drowning may occur.

6. WARNING - Install the plunge pool so that water can be easily drained out of the compartment containing electrical components so as not to damage equipment. Also, when installing plunge pool, allow at least 2 feet of clearance around the perimeter of the plunge pool to provide enough room to access for servicing. Contact your local dealer for their specific requirements.

7. WARNING-TO REDUCE THE RISK OF INJURY:

- REMINDER - Never allow anyone to dive into a plunge pool. Always enter feet first.
- Always enter and exit a plunge pool slowly.
- Do not use the plunge pool alone.
- Before entering the plunge pool, always measure the water temperature

IMPORTANT SAFETY INSTRUCTIONS

7. WARNING-TO REDUCE THE RISK OF INJURY (CONT.):

- Persons suffering from obesity or with a medical history of heart disease, diabetes, high or low blood pressure or circulatory system problems should consult a physician before using a plunge pool.
- The use of alcohol, drugs, or medication before or during plunge pool use may lead to unconsciousness with the possibility of drowning.

- Since excessive water temperatures have a high potential for causing fetal damage during early months of pregnancy, pregnant or possibly pregnant women should limit plunge pool water temperatures to 104° F (40° C).
- Persons using medication should consult a physician before using a plunge pool since some medication may induce drowsiness while other medication may affect heart rate, blood pressure, and circulation

Excessive water temperature can be dangerous. The water in the plunge pool should never exceed 104° F (40° C). Water temperatures between 100° F (38° C) and 104° F (40° C) are considered safe for a healthy adult. Lower water temperatures are recommended for extended use (exceeding 10 minutes) and for young children, Long exposures at higher temperatures can result in Hyperthermia.

- Children's body temperature can increase more rapidly than adults in the same water with elevated temperatures (above 99° F). Children should spend less time in water above body temperature than adults.

WARNING!

Hyperthermia: Hyperthermia occurs when the internal temperature of the body reaches a level several degrees above the normal body temperature of 98.6° F.

THE SYMPTOMS OF Hyperthermia INCLUDE:

- Dizziness
- Fainting
- Drowsiness
- Lethargy
- Increase in internal body temperature

THE EFFECTS OF Hyperthermia INCLUDE:

- Unawareness of impending hazard
- Failure to perceive heat
- Failure to recognize the need to exit plunge pool
- Physical inability to exit plunge pool
- Fetal damage in pregnant women
- Unconsciousness resulting in potential of drowning

8. REMINDER - A safe temperature for swimming or aquatic exercise is around 80° (27° C).

NOTE - People with infections or sores should not use the plunge pool. Warm and hot water temperatures may allow the growth of infectious bacteria if not properly disinfected.

IMPORTANT SAFETY INSTRUCTIONS

9. DANGER - RISK OF ELECTRIC SHOCK.

Do not permit any electric appliance, such as a light, telephone, radio or television within five (5) feet (1.52 m) of the plunge pool. Never operate any electrical appliances from inside the plunge pool or while wet.

10. WARNING - RISK OF SUFFOCATION.

If this plunge pool is equipped with a heater, it is intended for outdoor use only, unless proper ventilation can be provided for an indoor installation.

11. CAUTION - RISK OF ELECTRIC SHOCK.

Do not leave the Audio compartment open.

12. CAUTION - RISK OF ELECTRIC SHOCK.

Replace components only with identical components.

13. WARNING - PREVENT ELECTROCUTION.

Do not connect any auxiliary components (for example, additional speaker, headphones, additional audio/video components etc.) to the system.

These units are not provided with an outdoor antenna.

Do not service this product yourself as opening or removing covers may expose you to dangerous voltage or other hazards. Refer all servicing to your qualified plunge pool tech.

If the power supply cord(s) are damaged, if water is entering the speaker, Audio compartment, or any other component in the electrical equipment compartment area, the protective shield is showing signs of deterioration, or there are signs of other potentially hazardous damage to the unit, turn off the circuit breaker from the wall and contact or refer to your service technician.

14. DANGER - RISK OF ELECTRIC SHOCK.

Do not permit any electric appliance, such as a light, telephone, radio or television within five (5) (1.52 m) feet of the plunge pool.

A green colored terminal or a terminal marked G, GR. Ground, Grounding or the symbol shown in Figure 14.1 of UL1563 is located inside the supply terminal box or compartment. To reduce the risk of electric shock, this terminal must be connected to the grounding means provided in the electric supply service panel with a continuous copper wire equivalent in size to the circuit conductors supplying this equipment.

Two lugs marked "Bonding Lugs" are provided on the external surface or on the inside of the supply terminal box or compartment. To reduce the risk of electric shock, connect the local common bonding grid in the area of the plunge pool to these terminals with an insulated or bare copper conductor not smaller than No. 8 AWG.

All field-installed metal components such as rails, ladders, drains or other similar hardware with 3m of the plunge pool shall be bonded to the equipment grounding bus with copper conductors not smaller than No. 8 AWG.

CAUTION - Test the ground fault circuit interrupter before each use of the plunge pool.

CAUTION - Read the instruction manual.

CAUTION - Adequate drainage must be provided if the equipment is to be installed in a pit, or equivalent.

WARNING - Water temperature in excess of 104°F (40°C) may be injurious to your health.

WARNING - Disconnect the electric power before servicing.

IMPORTANT SAFETY INSTRUCTIONS

WARNING: Children should not use plunge pools or hot tubs without adult supervision.

WARNING: Do not use plunge pools or hot tubs unless all suction guards are installed to prevent body and hair entrapment.

WARNING: People using medications and/or having an adverse medical history should consult a physician before using a plunge pool or hot tub.

WARNING: People with infectious diseases should not use a plunge pool or hot tub.

WARNING: To avoid injury, exercise care when entering or exiting the plunge pool or hot tub.

WARNING: Pregnant or possibly pregnant women should consult a physician before using a plunge pool or hot tub.

WARNING: Water temperature in excess of 104°F (40°C) may be injurious to your health.

WARNING: Before entering the plunge pool or hot tub measure the water temperature with an accurate thermometer.

WARNING: Do not use a plunge pool or hot tub immediately following strenuous exercise.

WARNING: Prolonged immersion in a plunge pool or hot tub may be injurious to your health.

WARNING: Do not permit electric appliances (such as a light, telephone, radio, or television) within 1.5 M of this plunge pool or hot tub.

CAUTION: Maintain water chemistry in accordance with manufacturer's instruction.

Hyperthermia occurs when the internal temperature of the body reaches a level several degrees above the normal body temperature of 98.6°F (37°C). The symptoms of Hyperthermia include drowsiness, lethargy, and an increase in the internal temperature of the body. The effects of Hyperthermia include

- a) unawareness of impending hazard
- b) failure to perceive heat
- c) failure to recognize the need to exit plunge pool
- d) physical inability to exit plunge pool
- e) fetal damage in pregnant women
- f) unconsciousness and danger of drowning

WARNING: THE USE OF ALCOHOL OR DRUGS CAN GREATLY INCREASE THE RISK OF FATAL Hyperthermia IN HOT TUBS AND Plunge pools.

WARNING: DANGER Failure to keep suction outlet components clear of debris, such as leaves, dirt, hair, paper and other material, can result in an increased potential for suction entrapment. Suction outlet components have a finite life. The cover/grate should be inspected frequently and replace at least every seven years, or if found to be damaged, broken, cracked, missing, or not securely attached.

If the fitting is missing or broken, replace with a fitting of equivalent rating or higher. Use of a lower rated suction fitting could result in entrapment of the body which could result in serious injury including drowning.

Do not use or operate plunge pool/hot tub if this suction fitting is missing, broken or not secured per instructions. The suction fitting is intended to prevent entrapment of the body. Use of the plunge pool/hot tub with a missing, broken or improperly secured suction great may result in serious injury including drowning.

When the plunge pool or hot tub is in operation, suction at this fitting. Users of the plunge pool or hot tub must not to come in contact with this fitting in such a way a to block its orifice. If a user of the plunge pool or hot tub blocks this fitting with his/her body, serious personal injury or drowning may occur.

BASIC INFORMATION

Congratulations on the purchase of your new plunge pool. Our goal is to provide you with a invigorating plunge pool that also warm, relaxing by incorporating a soothing water massage. In order to maximize the pleasure of your plunge pool, you will need to understand how it works.

The following operating and maintenance instructions are very important and must be followed carefully. With proper care and maintenance your plunge pool will provide you with years of satisfaction with minimum effort.

The pump and heater should be operated a minimum of two hours per day for cleaning and heating.

The length of time required to heat your plunge pool to the desired water temperature will vary, depending on the air temperature, season, and wind velocity. The use of a vinyl hard cover to minimize heat loss and to protect your plunge pool when not in use. Covers are available from your local plunge pool dealer.

The replaceable filter cartridge is trouble free and easy to clean. A routine cleaning is the best practice. Make sure the pump is off, then remove the cartridge. Wash it off using a water hose with a pressure nozzle and then reassemble. This should be done on a monthly basis.

Keep the plunge pool water level 2" (5 cm) above the skimmer. Never allow the water level to drop below the bottom of the skimmer opening. If the water level is too low, the skimmer will allow air into the water lines of the pump, causing it to lose its prime (waterflow). Running the pump without water flow will damage the pump seal assembly and could possibly result in further equipment damage, which will not be covered under warranty.

You should clean your plunge pool at least every 3-4 months. Drain the plunge pool water and use a gentle liquid cleanser. DO NOT use hard brushes or abrasive cleaners. Fill with regular tap water and chemically treat the water for a clean and healthy plunge pool.

The spa or plunge pool water shall be tested and treated in accordance with local codes.

NOTE: For Pool and Hot Tub Water Sanitation, see Uniform Swimming Pool, Spa and Hot Tub Code, Chapter 5 - Water Quality.

CAUTION!

CAUTION: Cover must be kept on plunge pool at all times when plunge pool is not in use. Direct exposure to sunlight can damage plastic parts and interior surface, jets, or any interior components. Damage caused by exposure to the sun will not be covered under warranty.

WARNING!

Do not use soft water. It may harm your acrylic.

DANGER!

- a) Replace damaged cord immediately.**
- b) Do not bury cord.**
- c) Connect to a grounded, grounding type receptacle only.**

NORTH AMERICAN ELECTRICAL INSTALLATION REQUIREMENT'S

HAVE YOUR ELECTRICIAN READ THE FOLLOWING INFORMATION BEFORE INSTALLATION BEGINS

Electrical connections made improperly, or the use of wire incorrectly sized, may continually blow fuses in the electrical equipment box, may damage the internal electrical controls and components. Any of these conditions may be unsafe and will void the warranty.

It is the responsibility of the plunge pool owner to ensure that electrical connections are made by a qualified electrician in accordance with the National Electrical code and any local and state electrical codes in force at the time of installation. This product shall be installed in accordance with local codes.

These connections must be made in accordance with the wiring diagrams found inside the control box. This equipment has been designed to operate on 60Hz, alternating current only, 240 volts are required. Make sure that power is not applied while performing electrical installation. A copper bonding lug has been provided on the electrical equipment pack to allow connection to local ground points. The ground wire must be at least 8 AWG copper wire and must be connected securely to a grounded metal surface such as a cold water pipe. The electrical supply for your plunge pool must include a 60 AMP switch or circuit breaker to open all non-grounded supply conductors to comply with section 422-20 of the National Electrical Code. This disconnect must be readily accessible to the plunge pools occupants, but installed at least five feet from the plunge pool but within sight. A ground fault circuit interrupter (GFCI) must be used to comply with section 680-42 of the National Electrical Code. A GFCI is designed to automatically shut off power to a piece of equipment when a ground fault is detected.

Power hook-up to the plunge pool must be a 240 volt 3 wire plus ground (8 AWG copper).

Route the cable into the equipment area for final hookup to terminals inside the control panel. To install the wiring for the in.ye plunge pool control, you'll need a Phillips screwdriver and a flat screwdriver. Loosen the 2 screws in the Control box. Remove 5 1/2" of cable insulation, Strip away 1" of each wire insulation, Pull the cable through the cutout of the box and secure it with a strain relief (1" NPT strain relief; hole diameter: 1.335"). Make sure that only the uncut sheathing is clamped at this opening.

Push the color-coded wires into the terminals as indicated on the sticker and use the flat screwdriver to tighten the screws on the terminals.

After making sure wire connections are secure, push them back into the box and close the door. Tighten the 2 screws in the Control box. Connect the bonding conductor to the bonding lug on the front of the in.xe Plunge pool Pack

(a grounded electrode conductor shall be used to connect the equipment grounding conductors). The plunge pool must be hooked up to a "dedicated" 240 volt, 40 amp breaker and GFCI. The term "dedicated" means the electrical circuit for the plunge pool is not being used for any other electrical items (patio lights, appliances, garage circuits, etc.) If the plunge pool is connected to a non-dedicated circuit, overloading will result in "nuisance tripping", which requires resetting of the breaker switch located in the house main electrical panel.

(Excludes any 110/120 volt models.)

Plunge pool WIRING DIAGRAM

Wiring Requirements

- 2-Hots, 1-Neutral, 1-Isolated Ground
- 4 Wire #8 AWG minimum 75°C copper conductor

Factory Recommended G.F.C.I. Load Center Wiring

Note: The white neutral wire from the back of the GFCI MUST be connected to an incoming line neutral. The internal mechanism of the GFCI requires this neutral connection. The GFCI will not work without it.

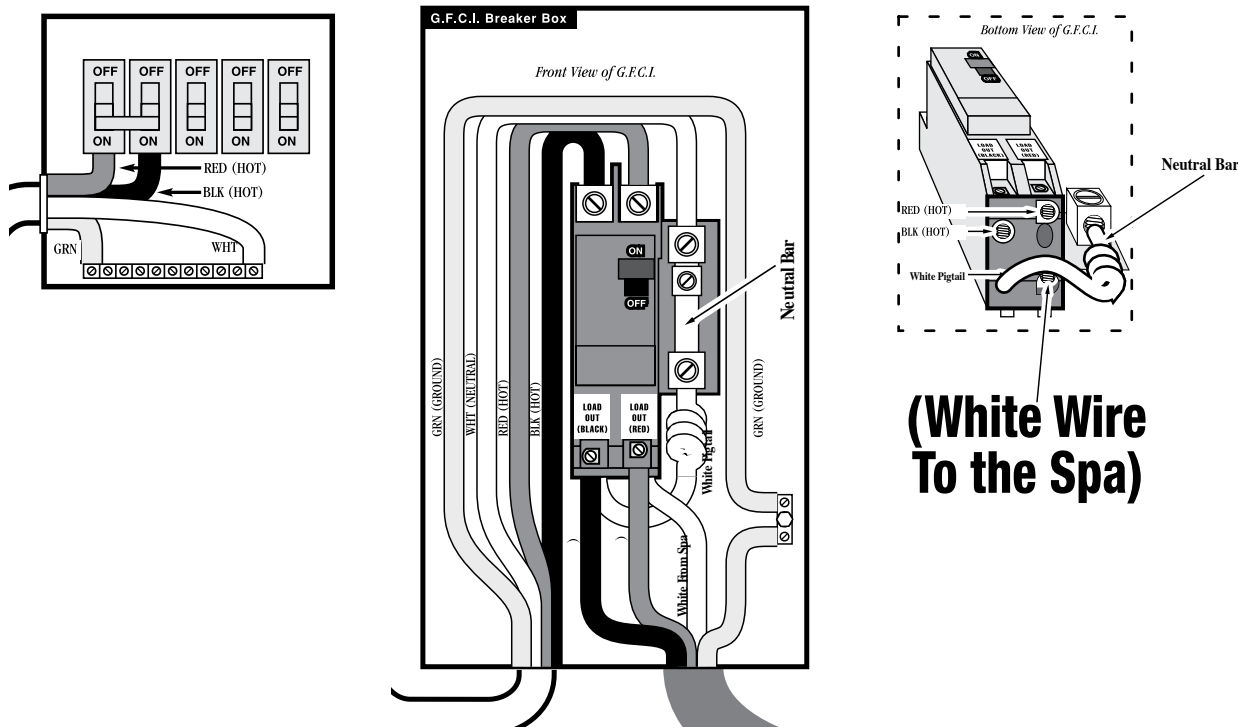

For spa wiring configuration please refer to page 22 or equipment pack for detailed information.

⚠ NOTE!

Note: Connection order may vary by pack model, please refer to equipment pack panel for proper connection order.

US / CANADA WIRING SINGLE PACK DIAGRAMS

TYPICALLY 15' & 19' PLUNGE POOL

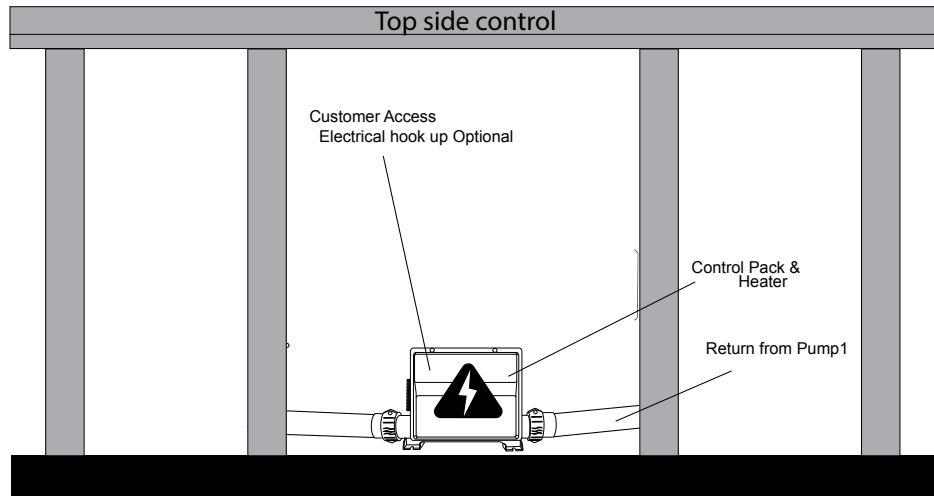

ELECTRICAL WIRING: NORTH AMERICAN MODEL

Refer to wiring diagram in the enclosure box lid for more information.

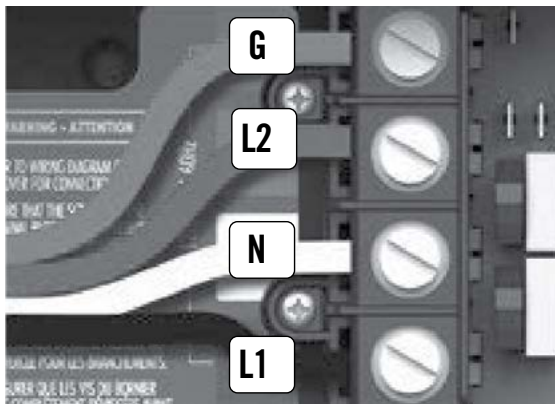

240 V (4 wires)

Insert each wire into the appropriate socket of the main entry terminal block according to the color code indicated on the sticker. Use a flat-head screwdriver to tighten the screws on the terminal (please refer to the sticker inside the casing to see the torque to apply).

After making sure wires are securely connected, push them back into the box and replace the cover.

Do not over tighten cover screws (torque to 8 in. lb mas (0.9 N. m)).

Connect the bonding conductor to the bonding lug on the front of the spa pack (a ground electrode conductor should be used to connect the equipment grounding conductors).

⚠ NOTE!

Note: Connection order may vary by pack model, please refer to equipment pack panel for proper connection order.

EUROPEAN ELECTRICAL INSTALLATION REQUIREMENT'S

HAVE YOUR ELECTRICIAN READ THE FOLLOWING INFORMATION BEFORE INSTALLATION BEGINS

Electrical connections made improperly, or the use of wire incorrectly sized, may continually blow fuses in the electrical equipment box, may damage the internal electrical controls and components. Any of these conditions may be unsafe and will void the warranty.

It is the responsibility of the plunge pool owner to ensure that electrical connections are made by a qualified electrician in accordance with the National Electrical code / IEC and any local and state electrical codes in force at the time of installation. This product shall be installed in accordance with local codes.

These connections must be made in accordance with the wiring diagrams found inside the control box. This equipment has been designed to operate on 50Hz, alternating current only, 230 volts are required. Make sure that power is not applied while performing electrical installation. A copper bonding lug has been provided on the electrical equipment pack to allow connection to local ground points. The ground wire must be at least 10 AWG copper wire and must be connected securely to a grounded metal surface such as a cold water pipe. The electrical supply for your plunge pool must include a 32 AMP switch or circuit breaker to open all non-grounded supply conductors to comply with section 422-20 of the National Electrical code / IEC. This disconnect must be readily accessible to the plunge pools occupants, but installed at least five feet from the plunge pool but within sight. A ground fault circuit interrupter (GFCI) must be used to comply with section 680-42 of the National Electrical code / IEC. A GFCI is designed to automatically shut off power to a piece of equipment. Route the cable into the equipment area for final hookup to terminals inside the control panel. To install the wiring for the in.ye

plunge pool control, you'll need a Phillips screwdriver and a flat screwdriver. Loosen the 2 screws of the Plunge pool Pack door and open it. Remove 5 1/2" of cable insulation. Strip away 1" of each wire insulation. Pull the cable through the cutout of the box and secure it with a strain relief (1" NPT strain relief; hole diameter: 1.335"). Make sure that only the uncut sheathing is clamped at this opening.

when a current fault is detected.

Power hook-up to the plunge pool must be a 230 volt 4 wire plus ground (10 AWG copper) (Where 3 phase power is used)

Push the color-coded wires into the terminals as indicated on the sticker and use the flat screwdriver to tighten the screws on the terminals. After making sure wire connections are secure, push them back into the box and close the door. Tighten the 2 screws of the Plunge pool Pack door. Connect the bonding conductor to the bonding lug on the front of the in.xe Plunge pool Pack (a grounded electrode conductor shall be used to connect the equipment grounding conductors). The plunge pool must be hooked up to a "dedicated" 230 volt. The term "dedicated" means the electrical circuit for the plunge pool is not being used for any other electrical items (patio lights, appliances, garage circuits, etc.) If the plunge pool is connected to a non-dedicated circuit, overloading will result in "nuisance tripping" which requires resetting of the breaker switch located in the house main electrical panel.

(EUROPEAN) WIRING CONNECTIONS

Electrical wiring: European model

Refer to wiring diagram in the control box lid for more information.

WARNING – European models must always be connected to a circuit protected by a Residual-Current Device (RCD)

Connect wiring of the electrical service box, RCD, and pack terminal block is essential! Check your electrical code for local regulations. Only copper wire should be used, never aluminum.

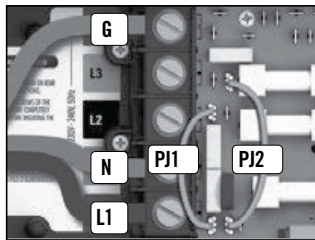

1-phase

Connect PJ1 between P37 and P49

Connect PJ2 between P50 and P26

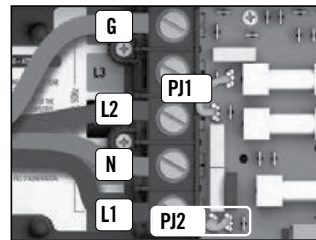

2-phase

Connect PJ1 between P37 and P26

Connect PJ2 between P50 and P49

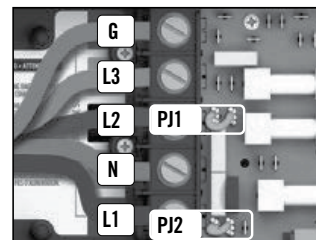

3-phase with single neutral

Connect PJ1 between P37 and P38

Connect PJ2 between P50 and P49

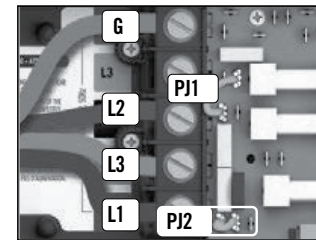

3-phase Delta (no neutral)

Connect PJ1 between P37 and P26

Connect PJ2 between P50 and P49

input voltage: 230V, 50Hz (Line-to-Neutral)

Only for countries where Line-to-Line input voltage: 230V, 50Hz.

Insert each wire into the appropriate socket of the main entry terminal block according to the color code indicated on the sticker. Use a flat-head screwdriver to tighten the screws on the terminal.

After making sure wires are securely connected, push them back into the box and replace the cover. Do not over tighten cover screws (torque to 8 in. lb max {0.9 N.m}).

Connect the bonding conductor to the bonding lug on the front of the plunge pool pack (a grounded electrode conductor should be used to connect the equipment grounding conductors). Bonding conductor must meet local electrical code.

15' & 19' PLUNGE POOL SCHEMATIC

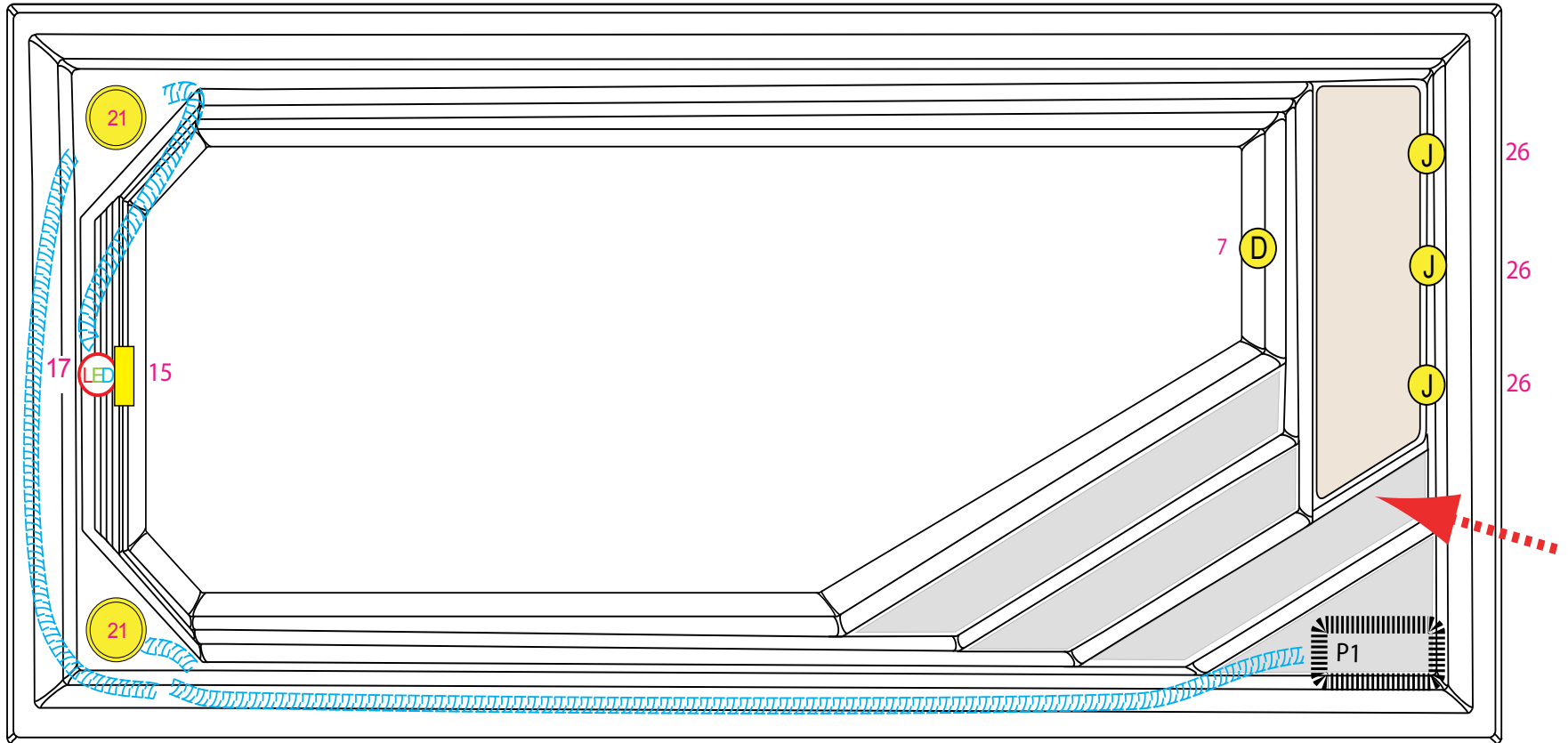

⚠ NOTE!

DRAWING MAY VARY - Manufacturer has reserved rights for any changes or modifications.

15' & 19' PLUNGE POOL PLUG N PLAY SCHEMATIC

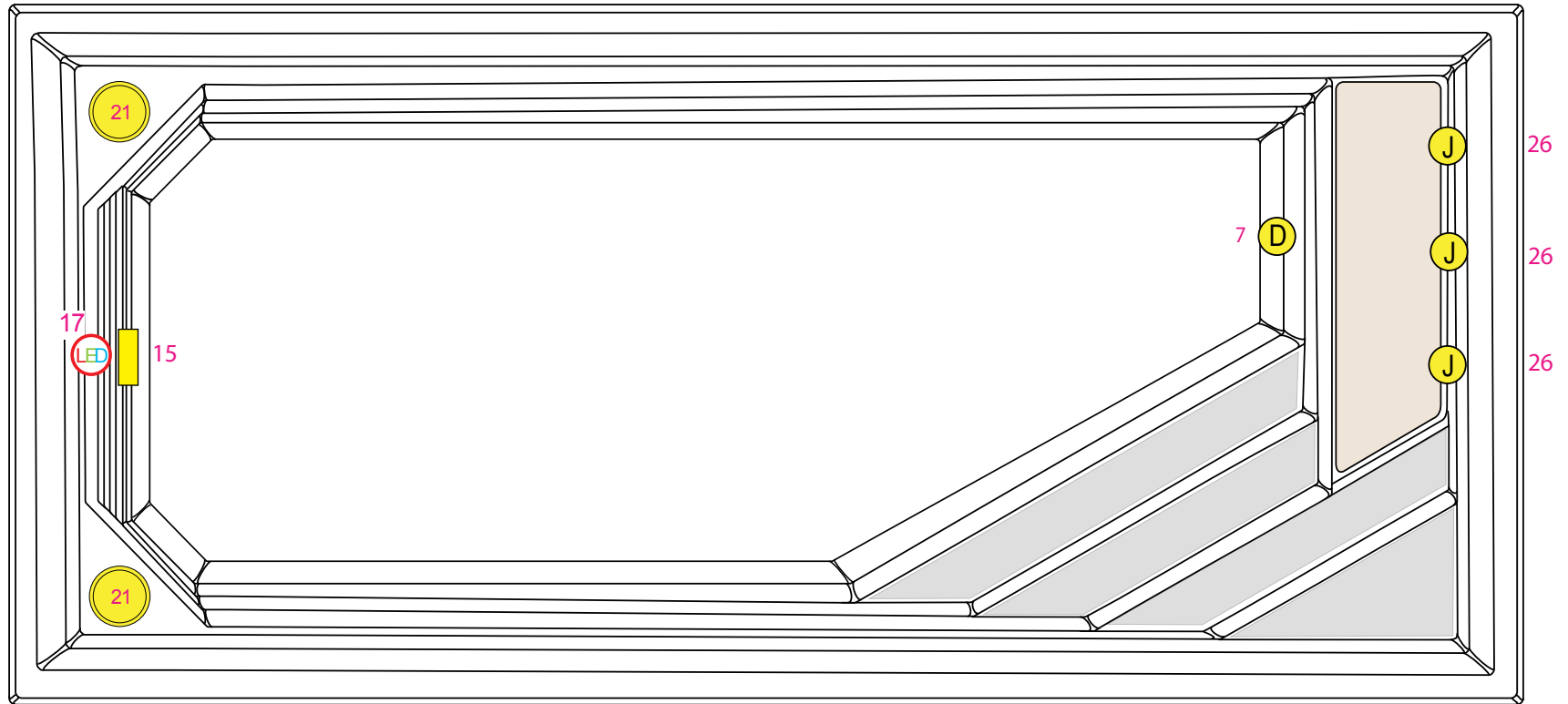

⚠ NOTE!

DRAWING MAY VARY - Manufacturer has reserved rights for any changes or modifications.

SET-UP & DELIVERY GUIDELINES

Surface And Pad Requirements

- The plunge pool, must be fully supported over the entire base. A typical installation on soil that will support 100 psi load, or a 5 inch (13cm) thick concrete with #4 rebar on 18 inch (46cm) centers. Condition at the site will determine the exact support requirements. Please contact your local contractor for adequate installation. **Damages caused by inadequate support will not be covered by the warranty.**
- If your plunge pool is located near sprinklers, adjust or cap them so they do not hit the siding of the plunge pool.

Balconies And Deck Requirements

- **DO NOT PLACE ANY Plunge pool ON ANY DECK OR BALCONIES.**
- Gates must be self-closing and self-latching.

Access

- All debris blocking access to the job site must be removed prior to delivery. Any trimming of trees or bushes, removal of debris, leveling of ground or other general maintenance must be done prior to delivery and is the responsibility of the customer.

General Consideration For Indoor Installation

Installing your plunge pool indoors creates an extremely different set of considerations. Here again, with proper planning, no matter what room your plunge pool goes in, it will be your favorite room.

- Work with your plunge pool dealer and contractor to insure all local building, electrical and plumbing codes are met. This product shall be installed in accordance with local codes.
- Plan for a floor drain to drain off excess water or for draining and cleaning your plunge pool.
- Finished material in your plunge pool room should also be capable of withstanding increased humidity.
- Excess Water: Normal use of the plunge pool causes large amounts of water to splash out of the unit. Depending on the specific installation, additional provisions may have to be made for proper removal of water.
- For plunge pool/hot tubs installed indoors, care should be taken to ensure adequate ventilation for the indoor plunge poolce, to avoid undesired build of humidity due to plunge pool water. For additional information on ventilation/humidity guidelines see the ASHRAE Handbook, HVAC Applications, I-P Edition, 4.5, 4.6, and 4.7.)
- Plunge pools that include gas-burning heating components, shall be installed in accordance with NFPA 54 or other local codes. This product shall be installed in accordance with local codes.

SAVE THESE INSTRUCTIONS

SET-UP & DELIVERY GUIDELINES

Electrical Requirements

- (NA) Your 220 Volt plunge pool pack will require a double pole 40 amp dedicated GFCI, ground fault circuit breaker. (Refer to page 14)
 - (EU) Your 230 Volt plunge pool pack will require a dedicated breaker. (Refer to page 18-19)
- Caution: Connect only to a circuit protected by a class A ground fault circuit interrupter.
- Extension cords are not to be used in conjunction with operation of the plunge pool. Low voltage damage could result, which is not covered by warranty.
 - If you have any doubts, have your electrical system checked by a licensed electrician.
 - Use copper conductors only.

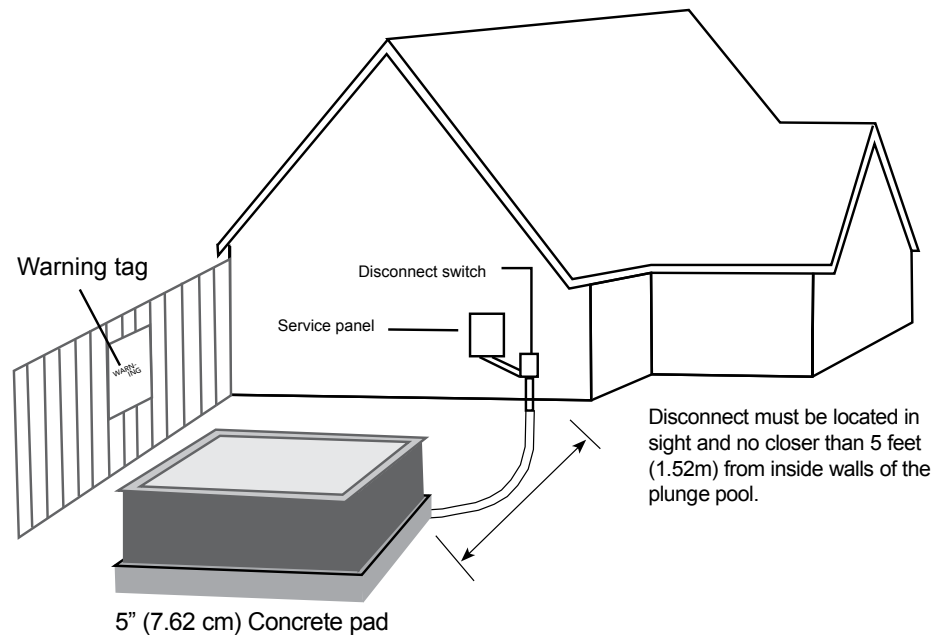

⚠ NOTE!

It is the customer's responsibility to acquire necessary permits and to arrange for installation and hook up of the electrical power by a licensed electrician.

GENERAL PRE-OPERATION INSTRUCTIONS

Priming Pump For Electrical Packs

The power pack system is located under the skirting. The equipment can be serviced by simply removing the door. The door is located on the side of the plunge pool where three panels are located the side where the topside control panel is located.

It is important to make sure that all of the air is out of the pump(s) before operating. To do this follow procedures below:

- Turn off power at the breaker
- Make sure the gate valves are open
- Fill the plunge pool with water going through the filter
- Turn the power on at the breaker
- Start the pump on low speed and water should start circulating within one to two minutes. If water does not start circulating, turn pump from low to high until water is flowing.
- If pump still does not prime, please see “Trouble Shooting Guide” located in the back of this manual

⚠ NOTE!

Note: Equipment style and location will vary by model

Set thermostat, located on top side control panel, to desired temperature and continue heating until desired temperature has been reached.

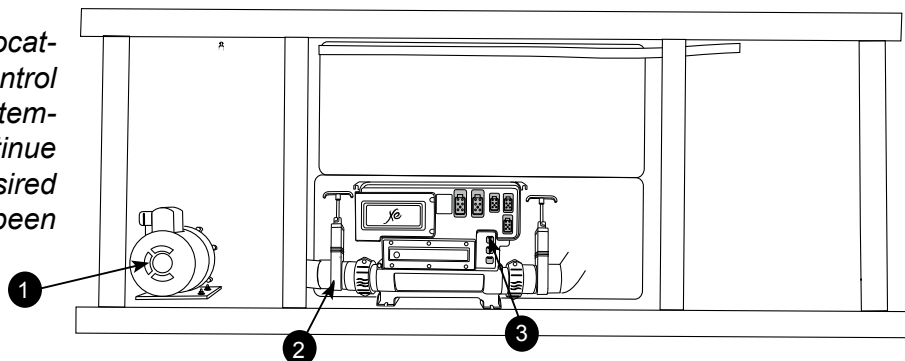

- ① Pump (if equipped)
- ② Gate Valve
- ③ Equipment Pack

⚠ WARNING!

WARNING: Do not run plunge pool with gate valves closed or run pump with no water circulating in plunge pool for long periods. This could damage the plunge pool equipment.

Filter Locations

Dual Filter Location (Canister Style) - applies to 15' & 19' Plunge Pool

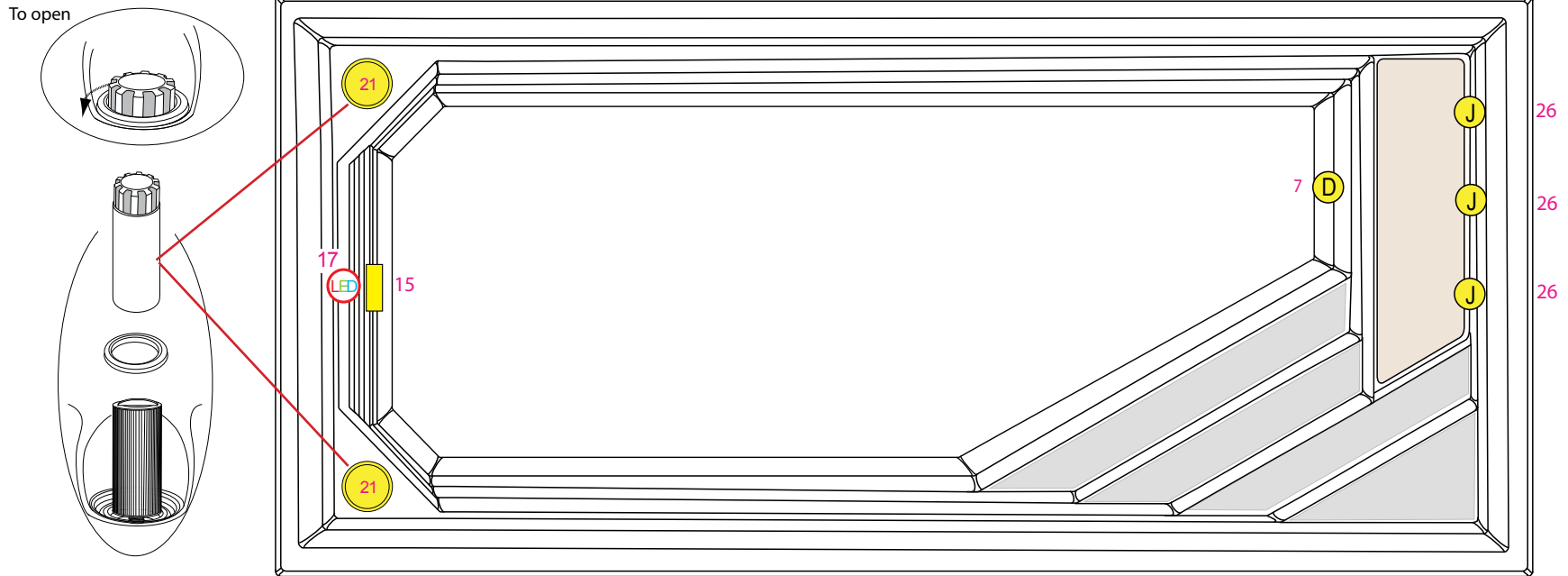

⚠ NOTE!

Note: Location will vary by model

FILTER MAINTENANCE

Filtration starts as soon as water flow is steady through the filter. The filter cartridge removes body oil and debris from the plunge pool water, as they can cause flow resistance. A dirty cartridge will decrease flow and may prevent the plunge pool from heating properly. Therefore, regular filter cleaning is essential.

Cleaning And Replacing Filter Cartridge

Your plunge pool filter(s) have been designed for quick and easy maintenance.

Open Style

- Turn off power at the breaker.
- Remove basket from filter canister.
- Remove filter cartridge and clean with a garden hose equipped with a high pressure nozzle or soak in filter cartridge cleaner if necessary or at every other regularly scheduled cleaning. Rinse filter thoroughly before installing.
- Place clean cartridge in filter canister
- Replace basket weir in filter canister.

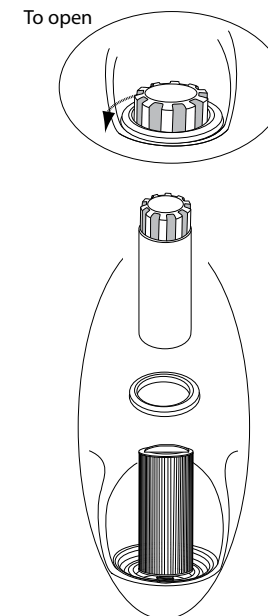

⚠ NOTE!

Note: The filter should be inspected and cleaned on a monthly basis.

GENERAL Plunge pool MAINTENANCE

SPA COVER CARE

- 1) Use a soft broom to remove accumulation after every snowfall or ice storm.
- 2) Splash cool tap water on the hardware to free them if they become frozen shut. Household lubricating oil will keep the lock free, but apply carefully because it can damage the cabinet finish.
- 3) We recommend a good treatment with vinyl conditioner before the first snow or ice. If possible, treat during the winter too.
- 4) Monitor your water chemistry. Even if the plunge pool is not used regularly, improper water chemistry can cause a mildew build-up on the cover. Clean, PH controlled water will prolong the life of the cover.
- 5) If mildew is found, remove foam cores from the vinyl encasement. Mix 1 gallon of water, a teaspoon of mild dish washing soap and a cup of bleach. With a soft bristle brush, scrub the inside and outside of the vinyl encasement thoroughly. Take a washcloth and wipe down each foam core; rinse thoroughly. Place the encasement in the sun and foam cores in the shade to dry. Once everything is thoroughly dry, spray the cores and encasement with a mildew inhibitor. Allow to dry completely, then reassemble. The key here, of course, is to maintain proper water chemistry to avoid mildew.
- 6) We suggest rotating the cover every six months to maintain even wear. Unzip the cover, remove the foam cores, turn over and reassemble.
- 7) The cover is an important safety feature. Even with normal usage and proper maintenance, the plunge pool cover will over time need to be replaced. Contact your local dealer or visit us online at covers@dynastyplungepools.com to inquire a replacement cover.
- 8) The plunge pool manufacturer recommend the plunge pool to be secured to prevent unauthorized access, in accordance with local code requirements.

**Ask Your Dealer About Using A Cover Lifter
PROTECT YOUR COVER!**

Proper Maintenance For Acrylic

For normal care and cleaning use a soft cloth or sponge with soap and water. Rinse well and dry with a soft clean cloth. If using a household cleaner, make sure it is recommended for use on acrylic by the manufacturer. Never use abrasive cleaners or cleaners with coarse grit, These will dull the surface. Remove any stains with 70% rubbing Alcohol. Rinse well and dry with a soft clean cloth.

The unit should be subject to periodic routine maintenance once every quarter to make sure that the unit is operating properly.

Pump and Heater Unions

Pump unions and heater unions may need to be tightened periodically. Loose connections are not covered under warranty

Plunge pool TERMINOLOGY

Equipment Access Panel

This is located behind the side panel below the topside control panel, this area houses the major components responsible for the plunge pools operation. The components include the pumps, heater, control panel box, ozonator, and led light system (if applicable). Pump and equipment placement may vary by model.

Cabinet Panels

These are located on all four sides of the plunge pool. All of the panels are removable should service be required.

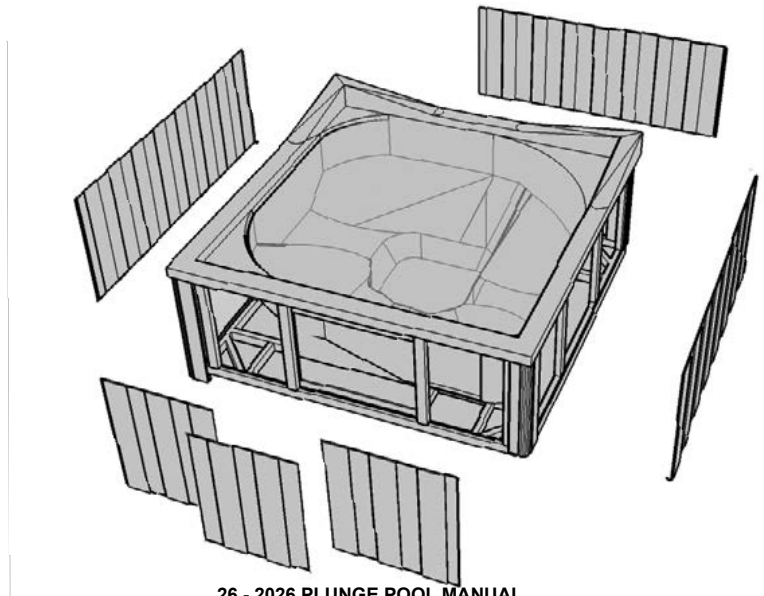

Plunge pool TERMINOLOGY

Draining Your Plunge

Because your plunge pool holds a relatively small amount of water, contaminants such as body oil, perspiration, dirt, hair, etc., may become quite concentrated. For this reason, the water should be drained and replaced every three months depending on use.

- Turn off power at the breaker.
- When water begins to drain out of the hose, be sure to drain the water to a convenient



1

The drain is located behind the equipment access panel



2

Once inside the cabinet, locate the hose with connector



3

Unscrew the cap off of the connector, then screw your garden hose to the threads of the connector.



4

Turn the tab to the open position by aligning it with the tube and connector. This will allow you plunge pool water to flow out.



5

Once your plunge pool has been drained, twist the tab to the closed position. Remove your garden hose, then replace the cap on the connector and simply close up the cabinet door

6

After draining is completed, Wipe down the inside of your plunge pool making sure your surface is dry and free from standing water. We recommend that after draining or cleaning your plunge pool that you put the cover back on. Avoid exposing the acrylic surface to direct sunlight for an extended period of time. Extended exposure can cause surface fading or cracking, which could void the acrylic warranty.

Alternative way to drain your spa. (Use a drain pump (not equipped) that can be purchased at most hardware stores. This makes the drainage much quicker and prevents from removing the cabinet panels.)

⚠ NOTE!

Note: Be sure that hose is on a downward grade to properly drain plunge pool.

Plunge pool TERMINOLOGY

Plunge pool

Your plunge pool light is designed for safety and is located in the interior wall of your plunge pool. The on/off switch is located on the topside control panel.

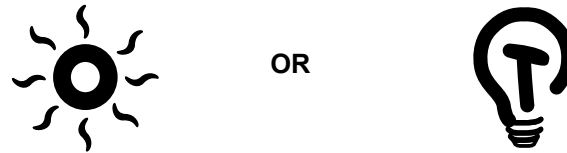

Plunge pool Heater

This element is an electric heater housed in a stainless steel tube. It is thermostatically controlled and equipped with a high-limit temperature safety shut-off sensor. The high-limit sensor cannot be reset until the temperature within the heater assembly drops several degrees below the shut-off temperature of 100° (°38 C) (varies by model). Should the high-limit switch trip repeatedly, contact your dealer or qualified service representative to diagnose the problem.

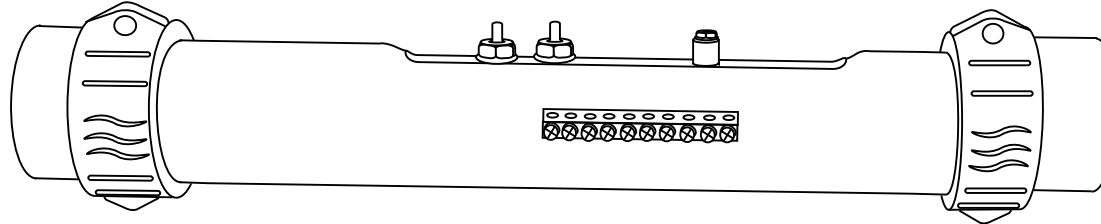

Plunge pool TERMINOLOGY

Gate Valves

Are installed for shut off/on water supply from heater or pump for service. For normal plunge pool operation valves should be in the open position (handle extended is open).

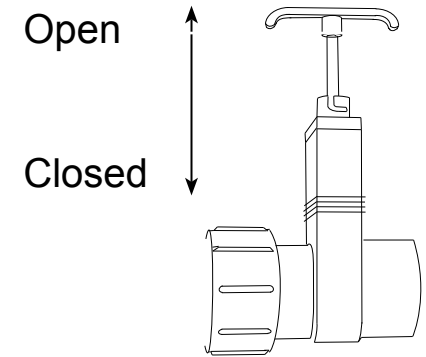

Main Pump

This produces water flow through heater and main jets. Also used for filtration. Can be controlled as desired by pressing the pump or pump 1 Button On Your Topside Control Panel. Refer To Quick Reference Card For Filtration Frequency And Duration.

Plunge pool WATER MAINTENANCE

You need to keep your plunge pool clean and ready to use. When you enter your plunge pool, you bring in as much contamination as 50 people would in a normal size swimming pool. Because your plunge pool is such a small, enclosed environment, it needs to be a sanitary place. We accomplish this with a simple three step process:

- 1) Balance
- 2) Filtration
- 3) Sanitation

The water that comes from your tap at home is fine for showers or bathing, because it is drained immediately after use. In a plunge pool, your water is used for up to three months. Hot water is a breeding ground for bacteria, so sanitizing becomes necessary, as well as maintaining a specific mineral balance. Having that mineral balance in place ensures that the water, which is naturally corrosive to metal, will not cause damage to the plunge pool equipment. We recommend weekly water testing using a hot tub water test kit for plunge pools that is readily available from your dealer or online.

When adding chemicals, broadcast the granules across the water while the pumps are running to prevent undissolved solids from settling on the acrylic surface.

Wait 15 to 20 minutes before covering the plunge pool after chemicals have been added.

The spa or plunge pool water shall be tested and treated in accordance with local codes.

NOTE: For Pool and Hot Tub Water Sanitation, see Uniform Swimming Pool, Spa and Hot Tub Code, Chapter 5 - Water Quality.

CAUTION!

CAUTION: The use of Tri-Chlor is not recommended for use in plunge pools. Tri-Chlor will cause damage to the acrylic surface and other surfaces in the plunge pool. Damage caused by the use of this chemical is not covered under warranty.

WARNING!

WARNING: Please be careful with chemicals - damage to the surface of the plunge pool can occur due to the improper use of chemicals such as trichlor or chlorine, chemical tablets, acids or plunge pool cleaners. Do not let undissolved chemicals lie on the surface of the plunge pool. Damage from chemical misuse is not covered under warranty. Improper water chemistry balance can damage the plunge pool surfaces and/or equipment, and is not covered under your warranty.

WARNING!

WARNING: Maintain water chemistry. PH Between 7.4-7.5, Alkalinity between 80-120 ppm, Calcium hardness between 200-400 ppm, free available chlorine 1-3 ppm (or Bromine).

Plunge pool WATER MAINTENANCE

Water Testing

Your plunge pool dealer is equipped to perform a thorough analysis of your plunge pool water. Take a one liter sample to the store and they will advise you on the products necessary to properly balance and care for your plunge pool. Unbalanced plunge pool water can quickly damage your equipment. Your plunge pool dealer will advise you on how to protect your investment.

⚠ WARNING!

Balance

Plunge pool water must have the correct chemical balance. Unbalanced water can irritate eyes, corrode the equipment, leave mineral deposits, and decrease the effectiveness of the sanitizer. Balanced water means establishing proper balance among total alkalinity, ph, calcium hardness and total dissolved solids.

Plunge pool WATER MAINTENANCE

Problem	Possible Cause	Action
Discolored Water	Green water due to copper getting into water: or MPS (monopersulfate compound) getting into bi-guanides	Add sequestering or chelating agent. If MPS and biguanides mix, do a major flush.
	Too much bromine.	Leave off cover so bromine dissipates more quickly.
Staining	Possible algae: yellow-green, pink, brown, or black.	Treat with algaecide. Worse cases, tetraborates.
	Minerals such as copper or iron making green or brown stains	Add sequestering or chelating agent.
Odor	Bromamines or chloramines from non-oxidized organic mater.	Shock with non-chlorine oxidizer such as potassium peroxydisulfate.
	Moldy dirty cover either inside or out.	Clean cover both inside and out with diluted bleach.

Plunge pool WATER MAINTENANCE

Problem	Possible Cause	Action
Cloudy Water/Haze	Total alkalinity in high range.	Add alkalinity decreaser (acid). Target 100.
	pH too high or too low.	Sprinkle or pour pH adjuster.
	Too little sanitizer in water.	Test and adjust pH & sanitizer to range.
	Fine particles won't filter out.	Add flocculant to skimmer, run pump, then remove & clean filters.
	Circulation Restricted Pump sucking air.	Check skimmer basket; clean. Make sure in-takes are open.
	Filter dirty.	Hose off filter: check for tears, fiber break-down, clogging or collapse: replace.
	Filter cycle too short.	Run filter system 24 hours & reclean and/or run main pump longer each day.
	Total dissolved solids have reached chemical saturation point.	Test TDS at dealer. Drain and refill plunge pool.
	White chips scaling off heater: Calcium level too high.	Drain and inch of water off, add fresh water. Test and adjust calcium to range. Add sequestering agent.

Plunge pool WATER MAINTENANCE

⚠ WARNING!

Do not leave your water treatment products outside. If subjected to extreme heat or cold, their effectiveness can be impaired.

KEEP ALL CHEMICALS OUT OF THE REACH OF CHILDREN!

WINTERIZING YOUR Plunge Pool

⚠ WARNING!

In areas of the country where the temperatures drop below 32° F (°O C), it is important to follow these directions:

When winterizing the plunge pool, we recommend putting RV antifreeze in the plunge pool and running it before draining the plunge pool.

- 1) If the plunge pool is not going to be used, drain completely. Be sure all water is removed. Break or loosen unions at each end of pump to en-sure water from pump area is removed. Remove pump freeze plugs if so equipped. Using a shop vacuum, vacuum all jets thoroughly to remove any water left over in the plumbing lines.
- 2) Do not turn unit off with water in the plunge pool. Frozen water may rupture plumbing. **Freeze damage repairs are not covered under warranty.**
- 3) Remove and clean filter cartridge. Store cartridge in a secure place to prevent freezing. If the plunge pool is going to be used, maintain normal operating procedures and ensure cover is in place when not in use.

⚠ NOTE!

Note: Freeze ups or damage caused by freezing are not covered under warranty!

SPRINGTIME START-UP

If your plunge pool has been winterized, the Manufacturer highly recommends that you contact an authorized dealer to restart your plunge pool. The following is an outline of the procedures involved.

- Make sure all o-rings for pumps are in place and undamaged.
- Make sure all the fittings that loosened are re-tighten.
- Replace all jet fittings, pump drain plugs, hose bib drains, and bleeder valves.
- Fill the plunge pool with water in a normal way,
- Run the jets on high for about 15 minutes.
- Drain the water.
- Put the filters back in.
- Refill the system and treat chemically as one would after a normal water change.
- Ensure Pump unions and heater unions are tightened. Loose connections are not covered under warranty

**For more information about winterizing your system,
or restarting a winterized system,
Please contact your local Authorized dealer.**

GENERAL TOPSIDE CONTROL



**IN.K300 MAIN KEYPAD
LCD DISPLAY**

GENERAL TOPSIDE FUNCTIONS

Pump 1	First Press	Second Press	Third Press
Sequence	Low speed*	High speed*	Off
Indicator	Blink*	On solid*	Off
Default	20 minute time out		
Sequence	Long press of 5 seconds		

Functionally of a long press A long press of 5 seconds will enable the Off mode. This mode allows you to stop all outputs including all automatic functions such as filter cycle, heat request and Smart Winter Mode purge for **30 minutes** to perform quick plunge pool maintenance. When the Off mode is active, the display will toggle between the “OFF” message, the clock and the water temperature. Press either, **Pump 1 or Pump 2, Blower or Econo** key to restart the system, before the expiration of the 30 minute display.

The plunge pool light will flash a few second before the end of the 30 minutes to warn you to system is about to resume its normal operation. When the system resumes it normal operation, the display shows On for 3 seconds.

GENERAL TOPSIDE FUNCTIONS

Increase set point 	First Press	Second Press	Holding Key
--	-------------	--------------	-------------

Display Swim spa set point Increase Set Point by 1 °F Increase Set Automatically by 1 °F

Limit N/A 104 °F (40 °C) 104 °F (40°C)

Default 95 °F (35 °C)

Indicator 

Decrease set point 	First Press	Second Press	Holding Key
--	-------------	--------------	-------------

Display Swim spa set point Decrease Set Point by 1 °F Decrease Set Automatically

Limit N/A 59 °F (15 °C) 59 °F (15°C)

Default 95 °F (35 °C)



Indicator 

Light 	First Press	Second Press
---	-------------	--------------

Sequence On Off

Indicator On solid Off

Default 2 hour time-out

Functionality of a long press Press to hold LIGHT key to access filter menu (up/down keys modify values.)
If none of these keys available.  

Duration Press LIGHT key to display next parameter, system will reset after last parameter.

Light 	First Press	Second Press
---	-------------	--------------

Parameter Display Value of x



Filter Cycle Duration Fd xx 2 to 10

Filter Cycle Frequency FF xx 0 to 23

Temperature Unit F °F or °C



Water Temperature Regulation

Functionality In a regulation cycle, the system first generates water flow through the heater housing and the plumbing, in order to ensure accurate water temperature readings as well as avoiding heater activation in dry conditions. After verifying pump activation and taking a water temperature reading if required, the system automatically turns the heater on to reach and maintain water temperature at Set Point.

Indicator  The “heater” indicator lights up when the heater is on.
 Icon flashes when taking water temperature reading.

Smart Winter Mode

Functionality Turn pumps on when ambient temperature is below 6°C
Duration Pumps activate for 1-minute (every 2 hrs or less)

Indicator  or  or 

GENERAL TOPSIDE FUNCTIONS

Filter (Purge)

Functionality Press hold the filter switch until the Clock icon lights up (about 5 second), 1st parameter will appear (Up/Down keys modify values)

Duration Press filter key to display next parameter, system will reset after last parameter.

Parameter	Display	Value of x
-----------	---------	------------

Time (Hour)	xx:30	oo to 12 (AM / FM) hour
--------------------	-------	-------------------------

Time (Minutes)	01:xx	00-59 minute
-----------------------	-------	--------------

Filter or Purge Cycle start time	FS xx PS xx	0 - 12 (AM / PM)
---	----------------	------------------

Filter Cycle duration	Fd xx	0-12
------------------------------	-------	------

Filter or Purge Cycle Frequency	FF xx PF xx	0-4
--	----------------	-----

Economy Activation	Ep xx	0 = Off 1 = On
---------------------------	-------	----------------

Economy Mode start time	ES xx	0-12 (AM / PM)
--------------------------------	-------	----------------

Economy Mode Duration	Ed xx	0-24
------------------------------	-------	------

Temperature Unit	F	F or C
-------------------------	---	--------

Economy First Press Second Press

Functionality When Economy mode is set, the pack regulates the water temperature 20 °F (11 °C) below actual set point.

Sequence	On	Off
----------	----	-----







Display	Display the toggle between Eco and water temperature	noE for 3 seconds
----------------	--	-------------------

GENERAL TOPSIDE DIAGNOSTIC MESSAGES

The list below shows the different error messages that can appear on the home screen. Refer to the troubleshooting and error codes of the Tech Book for your plunge pool pack system. Please note that if you are in a swim plunge pool configuration, the message may be followed by “Master” or “Slave” to designate from which pack the error is coming.

CODE	MESSAGE
HL	High Limit circuit is tripped!
FLO	No Flow condition for more than 2 hours
FLO	No Flow Condition
HR	A hardware error was detected (Relay Stuck)
OH	Plunge pool Temperature is Too High
Pr	Temp probes or detection circuit are defective.
ACH	Elevated Internal Temperature
FLC	The Pressure Switch is Closed
SP in	Input Voltage Issue
RH NC	Comm. error between in.xm2 - in.them
RH ID	in.xm2 Fuse #1 is blown
SC ER	Error detected during the learning mode
F1	in.xm2 Fuse #1 is blown.
F2	in.xm2 Fuse #2 is blown.
F3	in.xm2 Fuse #3 is blown.
ER1	Swim Plunge pools Configuration: slave unit is missing
HR	Hardware error was detected (Thermal fuse)
UPL	The plunge pool pack does not have valid software. Please reinsert valid in. stick to reprogram plunge pool pack
CFLO	No Flow Condition
HIBr	Add Fresh Water to the Plunge pool
HIBr	Add Fresh Water to the Plunge pool
LoBr	Add Bromine to plunge pool water
NoBr	Add Bromine to plunge pool water
Comm	Verify cable connections
Supp	Connect power cord in 240V source

GENERAL TOPSIDE DIAGNOSTIC MESSAGES & INSTRUCTIONS

	<p>An Internal hardware error has been detected in in.xe.</p> <ul style="list-style-type: none"> • Restart the plunge pool pack and start and stop all pumps and blower. • If error reappears, replace in.xe plunge pool pack.
	<p>Water temperature at the heater has reached 119°F. DO NOT ENTER Plunge pool WATER!!!</p> <ul style="list-style-type: none"> • Restart the plunge pool pack. • If error persists, measure the temperature with a digital thermometer and compare. Its reading with temp. On the display. Make sure the temp. Reading is lower than 119°F. • If problem persists, replace pack.
	<p>Temperature inside the plunge pool skirt is too high, causing the internal temperature in the in.xe to increase above normal limits.</p> <ul style="list-style-type: none"> • Remove plunge pool skirt and let system cool down, until the error clears.
	<p>The system did not detect any water flow while the main pump was running.</p> <ul style="list-style-type: none"> • Make sure valves are open and that water level is high enough. • Check and remove anything obstructing the filter. • Make sure there are no air locks or that no object obstructs the passage of the water in the heater channel. Pumps may make strange noises. Follow air lock procedure to clear them.
	<p>The Prr error message indicates a problem with regulation probe. The system is constantly verifying if temperature probe reading is within normal limits.</p> <ul style="list-style-type: none"> • Verify if regulation probe located above the heater is properly connected. • Replace in.xe heater is problem persists.
	<p>Water temperature in the plunge pool has reached 108°F. DO NOT ENTER Plunge Pool WATER!!!</p> <ul style="list-style-type: none"> • Measure the temperature with a digital thermometer and compare its reading with temp on the display. If temp reading is different, replace heater. • Remove plunge pool cover and let plunge pool cool down. • Add cold water and lower filter cycles. • If problem persists replace pack.

TROUBLESHOOTING

NO HEAT OR HEAT TOO LOW			
Probable Cause #1	<i>Dirty Filter</i>	Action	<i>Remove Filter Cartridge and Clean.</i>
Probable Cause #2	<i>Breaker at house off.</i>	Action	<i>Reset breaker at house. Breaker can appear to be on and one pole can be off. Turn breaker OFF then ON twice.</i>
Probable Cause #3	<i>Pump not primed.</i>	Action	<i>Refer to the section of this manual on pump priming.</i>
Probable Cause #4	<i>Improper line voltage.</i>	Action	<i>Have a licensed electrician check the line voltage.</i>

Plunge pool LIGHTS WON'T COME ON			
Probable Cause #1	<i>No water to pump.</i>	Action	<i>Replace bulb (non-warranty)</i>
Probable Cause #2	<i>Dirty Connection.</i>	Action	<i>Check to see if there is anything covering the connection on the housing that holds the light bulb.</i>

PUMP WILL NOT PRIME			
Probable Cause #1	<i>No water in pump</i>	Action	<i>Make sure water level i plunge pool is correct.</i>
Probable Cause #2	<i>Closed Gate valves or blocked lines.</i>	Action	<i>Open all gate valves. Check suction for blockage.</i>
Probable Cause #3	<i>Pump surges , jets lose and gain power, loose union or drain plus.</i>	Action	<i>Check Union on front or nose of pump to ensure tightness.</i>

JET(S) WONT COME ON			
Probable Cause #1	<i>Pump not primed.</i>	Action	<i>Refer to the section of this manual on pump priming.</i>
Probable Cause #2	<i>Gates valves closed..</i>	Action	<i>Check to see if gate valves are in the correct position. Check to see that pump is plugged in.</i>
Probable Cause #3	<i>Water diverter valve not adjusted correctly.</i>	Action	<i>Turn water diverter valve until desired water flow is obtained.</i>
Probable Cause #1	<i>Individual jet is closed.</i>	Action	<i>Turn the outer jet housing clockwise to tunr jet on.</i>

LOW WATER FLOW			
Probable Cause #1	<i>Dirty Filter.</i>	Action	<i>Remove filter cartridge and clean.</i>
Probable Cause #2	<i>Closed gate valves or blocked lines.</i>	Action	<i>Open all gate valves.</i>
Probable Cause #3	<i>Low voltage or incorrect voltage.</i>	Action	<i>Have a licensed electrician check the line voltage.</i>

TROUBLESHOOTING

Plunge Pool IS LEAKING

Probable Cause #1 <i>Loose Connections</i>	Action <i>Hand Tighten all disconnects and fittings. Check Joints and unions.</i>
---	--

MOTOR DOES NOT RUN

Probable Cause #1 <i>No power to motor.</i>	Action <i>Check power switches and circuit breakers. Check motor plug where plugged into control box.</i>
--	--

Probable Cause #2 <i>Pump jammed from foreign matter in impeller.</i>	Action <i>Call dealer for recommended action.</i>
--	--

Probable Cause #3 <i>Motor overheats on hot days while filtering.</i>	Action <i>Reprogram your controls to cycle during the coolest parts of the day and on shorter cycles. (see programming instructions).</i>
--	--

MOTOR RUNS HOT

Probable Cause #1 <i>Pump ran dry.</i>	Action <i>Call dealer for recommended action.</i>
---	--

Probable Cause #2 <i>Restricted suction lines.</i>	Action <i>Make sure all valves are open/clear suction of debris.</i>
---	---

Probable Cause #3 <i>Improper ventilation</i>	Action <i>Insure that vents on side of plunge pool are free and clear of any debris or landscaping. Plunge pool should also be located an adequate distance from any walls or fencing for good ventilation.</i>
--	--

NOTE!

Note: The pump motors will feel hot to the touch. This is normal. The Overheat Sensor will turn the motor off if there is an overload or high temperature problem.

Limited Warranty Summary

Please refer to the warranty card included with your product for complete warranty information. In order to receive prompt warranty service, you must register your plunge pool - ask your dealer about registering. The plunge pool manufacturer provides a limited warranty to our customers. It applies to the plunge pool structure, surface, plumbing, pumps, heater, blower, and controls. The limited warranty does not cover damage resulting from improper maintenance, improper installation, misuse, abuse, accident, fire, normal acts of God, wear and tear, or improper water maintenance. Unauthorized modifications of the plunge pool may void the warranty. Replacement costs associated with transportation, removal, and re-installation are the sole responsibility of the plunge pool owner.

We reserve the right to make changes in design or material of its products at any time without incurring liability. This limited warranty applies to the first retail purchaser and terminates upon any transfer of ownership.

Disclaimer:

The information in this manual is accurate to the best of Dynasty Spas knowledge. However, Dynasty Plunge pools, Inc. assumes no responsibility for errors or omissions. Nor is any liability assumed for damages resulting from use of the information contained herein.

At the time of print, this manual is accurate in its information. Dynasty Plunge pools reserves the right to change to improve its product without prior notice. To check on updated or for other information, please visit www.dynastyplungepools.com and follow the links to the owners hub section.

All rights reserved. Manufacturer reserves the right to make product modifications and enhancements. Rev date: 01232026

Safety Sign

The safety sign enclosed with your owner's manual packet should be permanently installed where visible to all users of the plunge pool. It is very important that you, as a plunge pool owner, review the important safety instructions and warnings before you operate your plunge pool. It is equally important that you instruct all users, even occasional ones, as to the warnings associated with plunge pool use.

Installer

Company: _____

Address: _____

Phone: _____

Warranty Submission Date: _____

**PLEASE REGISTER YOUR SPA ONLINE AT
WWW.REGISTERMYPWARRANTY.COM**

Model: _____

Serial Number: _____

Equipment Pack: _____

Color: _____

Date of Delivery: _____

**Spa Manufacturer 101
Dynasty Way Athens,
TN USA 37303**

